

2024 Recreational Trails Program Project Administration Guide

Missouri State Parks
Grants Management Section
PO Box 176
Jefferson City, MO 65102-0176
(573) 522-8773
(573) 751-8661
msspgrants@dnr.mo.gov



MISSOURI DEPARTMENT OF NATURAL RESOURCES
DIVISION OF STATE PARKS

TABLE OF CONTENTS

Table of Contents	i
List of Acronyms	iv
Section I. Project Administration Overview	1
Section II. NEPA Review and Determination	6
Completing the NEPA Determination Form	7
Section 106 Review	7
Threatened or Endangered Species	9
Section 6(f)(3) Lands	21
Impacts to Jurisdictional Waters	21
Water Quality Impacts	23
Floodplain Impacts	24
Air Quality	26
Hazardous Waste	26
Ozark National Scenic River ways	27
Wild and Scenic Rivers	28
Farmlands	28
Environmental Justice	30
Noise Impacts	31
Temporary Construction Impacts	31
Permanent Impacts to Travel Patterns	31
Public/Tribal Involvement	31
Certification of Responsible Person	31
Section III. Real Property Acquisition	33
Section IV. Project Development	36
Maintaining Your RTP Project File	36
Project Development Procedures	37
Contracting for Engineering and Design Related Services	37
Purchase/Service Contracts Under \$25,000	38
Contracting for Purchase/Service Contracts \$25,000 or Greater	38
Projects with a Federal Award \$500,000 or Less	39
Projects with a Federal Award Greater than \$500,000	39
Force Account Labor and Use of In-House Equipment	41
Donations	41
Signs	41
Invasive Species	41
Permitting	41
Accessibility	41
Trailhead Amenities	42
Trails/Trailside Amenities	42
Other Power-Driven Mobility Devices	43
Section V. Reimbursement and Reporting Requirements	45
Quarterly Reports	45
Amendment Requests	45
Time Extensions	45
Change in Project Scope	45
Change in Project Budget	45
Project Cancellation	46
Reimbursement Requests	46
Reimbursement Statement	46
Reimbursement Log	46
Individual and Volunteer Time Record	46

Equipment Use Log	46
Cost Documentation.....	46
Documentation of Contract Labor	46
Documentation of Force Account and In-House Equipment Usage	46
Documentation of Volunteer Services	47
Documentation of Purchase	47
Final Reimbursement Request	47
Section VI. Project Closeout and Post-Completion Requirements, and Remedies for Noncompliance	48
Project Completion.....	48
RTP Acknowledgement Sign	48
Project Closeout Packet.....	48
Final Reimbursement Request	48
Final Inspection Request Form.....	48
As-Built Site Map.....	48
As-Built Facility Plans	48
Post-Construction Certification.....	48
Control and Tenure Documentation	48
Record Retention.....	48
Long-Term Stewardship Responsibilities.....	49
Inspections	49
Public Access	49
Maintenance Requirements for Equipment Purchased with RTP Funds	49
Remedies for Noncompliance.....	49
Appendix A. NEPA Determination Form	50
Appendix B. Real Property Acquisition Documentation	64
Real Property Acquisition Documentation Checklist.....	64
Sample Notice of Interest.....	65
Sample Waiver Valuation	66
Sample Written Offer to Purchase	67
Sample Written Statement of Just Compensation	68
Sample Waiver of Right to Just Compensation	68
Appendix C. FHWA-1273 Required Contract Provisions for Federal-Aid Construction Projects.....	69
Appendix D. Missouri Department of Natural Resources Federal Financial Assistance Agreements General Terms and Conditions.....	85
Appendix E. Contract Compliance Required Documentation	105
Affidavit of Compliance with Prevailing Wage Law	106
Certification of Non-Segregated Facilities	107
Certification Regarding Department, Suspension, and Other Responsibility Matters, Drug-Free Workplace Requirements and Lobbying	108
Business Entity Certification, Enrollment Documentation, and Affidavit of Work Authorization.....	111
Appendix F. Buy America	115
Certificate of Materials Origin	116
Appendix G. Accessibility Checklist	118
Appendix H. Financial Assistance Agreement, Reporting, Reimbursement and Amendment Request Forms	163
Financial Assistance Agreement.....	164
Quarterly Report Form	166
Extension Request	167
Reimbursement Statement	168
Reimbursement Log	169
Individual and Volunteer Time Record	170
Equipment Use Record	171
FHWA Change Order Form	172

Appendix I. Project Closeout Forms and Checklist.....	173
Project Closeout Packet Checklist	173
Final Inspection Request	174
Post Construction Certification	175
Declaration to Record Stewardship Requirements.....	176

LIST OF ACRONYMS

ABA	Architectural Barriers Act
ADA	Americans with Disabilities Act
ATV	All-Terrain Vehicle
BABA	Build America, Buy America
CAA	Clean Air Act
CE	Categorical Exclusion
CFR	Code of Federal Regulations
CWA	Clean Water Act
DBE	Disadvantaged Business Enterprises
DOJ	U.S. Department of Justice
DSP	Division of State Parks
EA	Environmental Assessment
EIS	Environmental Impact Statement
EPA	Environmental Protection Agency
ESA	Endangered Species Act
FAST	Fixing America’s Surface Transportation (Act)
FEMA	Federal Emergency Management Agency
FFATA	Federal Funding Accountability and Transparency Act
FHWA	Federal Highway Administration
FONSI	Finding of No Significant Impact
GMS	Grants Management Section
IPaC	Information for Planning and Conservation
LWCF	Land and Water Conservation Fund
MBE	Minority Business Enterprise
MDC	Missouri Department of Conservation
MOA	Memorandum of Agreement
MPO	Metropolitan Planning Organization
NAAQS	National Air Quality Standards
NEPA	National Environmental Policy Act
NFIP	National Flood Insurance Program
NHPA	National Historic Preservation Act
NPDES	National Pollutant Discharge Elimination System
NPS	National Park Service
NRCS	Natural Resources Conservation Service
NTP	Notice to Proceed
NWP	Nationwide Permit

ONSR	Ozark National Scenic River ways
OPDMD	Other Power-Driven Mobility Devices
OHV	Off-Highway Vehicle
ORV	Off-Road Vehicle
ROD	Record of Decision
RTP	Recreational Trails Program
SHPO	State Historic Preservation Office
SWPPP	Storm Water Pollution Prevention Plan
T&E	Threatened and Endangered
TIP	Transportation Improvement Program
Uniform Act	Uniform Relocation Assistance and Real Property Acquisition Policies Act of 1970, as amended
USACE	U.S. Army Corps of Engineers
USFS	U.S. Forest Service
USFWS	U.S. Fish and Wildlife Service
WBE	Women Business Enterprise

SECTION I. PROJECT ADMINISTRATION OVERVIEW

Congratulations on having your proposed trail project recommended for funding through the 2024 Recreational Trails Program (RTP)! The Recreational Trails Program is a federally funded assistance program authorized by the U.S. Congress under the Fixing America's Surface Transportation (FAST) Act. The purpose of RTP is to help states provide and maintain trails and trail-related facilities for both motorized and non-motorized recreational use. For more information about RTP or the FAST Act, visit (http://www.fhwa.dot.gov/environment/recreational_trails/)

The U.S. Department of Transportation, Federal Highway Administration (FHWA), oversees RTP and has delegated administration of the program to the Missouri Department of Natural Resources. The Division of State Parks (DSP), a Division within the Department, has direct oversight of the program. Within DSP, the Grants Management Section (GMS) is the section responsible for assisting you with all aspects of applying for and administering your RTP grant project.

Now that you have received a notice of award letter from the Department, the following provides a general overview of the process for administering your grant, which includes requirements found in federal and state laws and regulations and terms and conditions of this grant. All terms of the federal to state grant award pursuant to 23 CFR 630.112 are incorporated by reference and imposed on you, the project sponsor, to ensure that the federal award is used in accordance with federal laws and regulations, and pursuant to 2 CFR 200.331 must be imposed on all contractors performing work under this program. The procedures and requirements herein are subject to changes made to laws and regulations subsequent to the publication of this guide. In the event that these procedures and regulations conflict with federal laws, regulations, and policies, the following order of precedence will control:

- 1) Federal law
- 2) Code of Federal Regulations
- 3) Terms and condition of grant award
- 4) RTP Project Administration Guide

Subsequent chapters of this guide detail the general process more thoroughly. Sponsors of trail-related projects have **three years** from the date the Financial Assistance Agreement (which consists of the Financial Assistance Agreement and all documents incorporated by reference) is signed to complete their RTP project. It is important that you, the project sponsor, demonstrate every effort to complete your project within the agreed-upon timeframe indicated on the Financial Assistance Agreement. To this end, GMS has created a trail-related project timeline example on page 5, outlining the anticipated timeframe for each phase of the project. Most projects will be completed well within the project timeline but it is acknowledged that unforeseen issues can arise that may delay project completion. GMS staff will work with project sponsors on a case-by-case basis for extension requests or other amendments to the project, the procedures for which are discussed in Section V of this manual.

- **Mandatory project administration workshops.** Sponsors are required to attend a mandatory project administration workshop. During the workshop, GMS staff will explain the requirements for administering the RTP grants. Additionally, they will help you understand the Federal Highway Administration's statutory provisions for Build America, Buy America as well as the federal requirements for conducting an environmental review of your project. At the project administration workshop, GMS staff will provide you with a copy of the Financial Assistance Agreement that will need to be signed by the project sponsor and submitted to the GMS office. Also during the workshop, GMS staff will provide you a copy of the Department's Sub-Recipient Information Form, which will need to be completed and submitted to the GMS office. The Sub-Recipient Information Form is required in response to the Federal Funding Accountability and Transparency Act (FFATA) of 2006. The FFATA legislation requires information on federal awards (federal financial assistance and expenditures) to be made available to the public via a single, searchable website, which is (www.USASpending.gov.) Additionally, staff will provide instruction on how to register to complete a State of Missouri Vendor Input/ACH-EFT Application (https://oa.mo.gov/sites/default/files/vendor_input_ach_eftd.pdf) which allows reimbursement funds to be transferred electronically to the sponsor's account at their bank or financial institution.
- **Project phasing.** As described in the grant application, projects will be administered by activity and associated budget presented per project phase. GMS will process all requests for reimbursement prior to authorization of the next phase of your project. Authorization of each phase requires the approval of the FHWA prior to being issued a notice to proceed with the next phase.

There are three phases:

- 1) **Phase I - Planning/Engineering/Environmental (also referred to as the design phase):** Phase I includes preliminary design, the preparation and submission of the NEPA Determination Packet, and final design.

- a) **Preliminary Design** defines the general project location and design concepts. It identifies the project elements in relation to property boundaries and existing features and includes but is not limited to eligible pre-award planning and environmental costs, as identified in the project sponsor's grant application.
- b) **NEPA review** includes documentation of compliance with the National Environmental Policy Act (NEPA) and other federal environmental laws, regulations, and Executive Orders which must be provided as part of an authorized construction project under RTP. Most RTP projects will qualify as Categorical Exclusions (CE) under NEPA. However, each project must be reviewed to assure that it does not have a significant impact on the environment. As part of the review, project sponsors are required to complete a NEPA Determination Form and provide concurrence documentation from various state and federal agencies in order for GMS and FHWA to determine if a project is classified as a CE, or if it requires an environmental assessment or environmental impact statement under NEPA. The NEPA Determination Form is provided in Appendix A and steps for completing the NEPA review are provided in Section II. During the workshop, GMS staff will explain the process for completing the NEPA review.
- c) **Final Design** includes the preparation of final construction plans and specifications for the performance of construction work. All necessary permits, railroad and utilities certifications should be secured during the Final Design Phase. Projects that do not include acquisition of real property may receive construction authorization in final design phase. GMS's approval of the project's procurement documents signifies the conclusion of the final design. Final design shall not proceed until NEPA approval is provided.

Please note: If significant design changes are made after the submission to GMS, the project sponsor will be required to submit a written request for a project scope change to GMS and FHWA for approval. This may also require reevaluation of the NEPA review.

In order for your project to remain active, you are strongly encouraged to complete and submit for approval your preliminary engineering, environmental review, and final design within six months of signing the Financial Assistance Agreement. You should begin the preliminary design of your project concurrently with the NEPA review process since the design phase will identify potential impacts to resources and any required permits. However, federal regulations do not allow for final design to proceed until the project has received its FHWA approval and NEPA notice to proceed letter. Once phase I work has been approved by GMS and FHWA, the project sponsor must submit their first reimbursement request packet. This packet should include all costs associated with Phase I of the project. If your project budget included costs associated with the federal share, you will be reimbursed for eligible costs at the proportional rate indicated on your Financial Assistance Agreement. If your project budget included costs only associated with the match, you will not be reimbursed at this phase and the match will be applied to future phases of the project. If your project budget does not include any costs associated with this phase, no request for reimbursement will be accepted. The GMS will process all requests for reimbursement prior to authorization of the next phase of your project. Authorization of each phase requires the approval of the FHWA prior to being issued a notice to proceed with the next phase. After completion of Phase I, the GMS will provide a NTP with Right of Way (Phase II).

- 2) **Phase II- Right-of-Way:** It is the project sponsor's responsibility to provide proof of right-of-way during their application. For projects that include the acquisition of additional right-of-way as part of the project, project sponsors will be required to comply with the Real Property Acquisition requirements in this RTP Project Administration Guide. All federally assisted real property acquisition, which includes private property acquired with RTP funds, must comply with the Uniform Relocation Assistance and Real Property Acquisition Policies Act of 1970, as amended. Also known as the "Uniform Act," this act ensures that landowners are fully informed of their rights and are justly compensated when selling or leasing private property or selling/leasing some type of interest in the property (such as an easement). As part of this assurance, the Uniform Act requires an appraisal and an appraisal review to be performed. If your project includes the acquisition of real property, Section III of this guide outlines the steps you must perform to show compliance with the Uniform Act. Appendix B provides the supporting documentation you will be required to submit to GMS to demonstrate compliance.

You have up to six months from the date you are authorized to begin phase II to provide GMS staff the documentation showing compliance with the Uniform Act (when required). Once the GMS receives your request for right-of-way approval, GMS will review the documentation and if it complies with the program requirements, submit it to FHWA for approval. Once FHWA approves the right-of-way, you will be sent a letter authorizing you to acquire the property (Right of Way NTP). **Property should not be acquired prior to Right of Way approval.** The project sponsor will then submit proof of ownership/interest, recorded RTP declaration, and a reimbursement request packet for phase II. Phase II costs shall include the cost for acquiring property by fee title, or the use of property by permanent or temporary easement, and all

eligible incidental costs including appraisal fees, titles searches, preparation of preliminary surveys, plats, and property descriptions. If your project budget included costs associated with the federal share, you will be reimbursed for eligible costs at the proportional rate indicated on your Financial Assistance Agreement. If your project budget included only costs associated with the match, you will not be reimbursed at this phase and the match will be applied to future phases of the project. If your project budget does not include any costs associated with this phase, no request for reimbursement will be accepted.

Please note: Project sponsors are not authorized to begin any construction activities until phase I and II have been approved and the project sponsor has been issued a notice to proceed with phase III.

- 3) **Phase III- Construction:** Approval to begin phase III means that you are authorized to begin construction. Project sponsors must use their own documented procurement procedures which reflect applicable state, local, and tribal laws and regulations in addition to the Buy America requirements outlined in Section IV of this guide. Project sponsors are encouraged to pay close attention to the procurement requirements in this guide. See Section IV for Buy America Provisions. Adequate supervision and inspection must be provided by the project sponsor to ensure projects are completed in conformance with design standards, construction contract documents, plans and specifications. The final inspection and closeout documents in Appendix I signify the conclusion of the construction phase and the completion of the project. Phase III costs shall include eligible construction costs. Grantees are encouraged to submit reimbursements as they are invoiced for project costs. A portion of at least 10% of the recipient's final reimbursement will be withheld until the final closeout process has been approved.
- **Notice to Proceed (NTP) letters.** Formal NTP letters will be issued by GMS that provide approval to proceed with specified phases of the project. These letters will be issued once all compliance requirements for each phase have been met. A project sponsor will receive an initial NTP letter authorizing expenses associated with planning, such as conducting the NEPA review and developing a preliminary project design. A second NTP letter would be issued for final design once GMS and FHWA staff review the required compliance documentation for NEPA determination and concur that the environmental review process has been completed. For projects that include acquisition of real property, a separate NTP letter would be issued upon receipt of documentation demonstrating compliance with the Uniform Act. All projects will receive a NTP prior to beginning any construction activities. **It's important to remember that you are not authorized to begin final design, acquire real property, or begin any construction activities until receiving a NTP letter for those particular phases of your project.** Any costs incurred prior to receiving NTP will not be reimbursed; however, some costs incurred prior to receiving NTP may be used as match, such as planning, engineering or environmental review costs (up to 10% of the total grant request). Costs in these categories incurred up to 18 months prior to construction authorization and its notice to proceed may be used as match if they were identified in your budget table and budget narrative at the time of application. Examples of planning costs include property appraisals and appraisal reviews for land acquisition and/or land donations. Examples of engineering costs include development of design and/or construction documents; and costs associated with the bidding process, such as advertisement and development of bid packets; etc. Examples of environmental review costs include costs associated with evaluations such as archaeological surveys, environmental approvals, and applicable permits.
 - **Project development.** Section IV. Project Development outlines the required documents you will need to maintain in your project file; the procurement procedures you are required to use, including the bid process for goods and contracted labor; and the submission of project plans and specifications for review, including demonstration of compliance (where required and where possible) with the Americans with Disabilities Act (ADA). **Project costs that do not abide by the bid procedures outlined in this section will not be eligible for reimbursement.**
 - **Requesting reimbursements and reporting project status.** Section V. Reimbursement and Reporting Requirements describes the process for submitting funding reimbursement requests, including required cost documentation and time accounting records; submitting quarterly status reports; and requesting project amendments, such as changes in project scope or time extensions.
 - **Project completion.** Section VI. Project Closeout, Post-Completion Requirements, and Remedies for Noncompliance outlines the process for submitting a final reimbursement request, the post-construction certification, as-built site maps and site plans, and other closeout documents that are required at the completion of the project to ensure the project meets all federal and state regulations. Section VI also describes the post-completion record retention, stewardship, operation and maintenance requirements a project sponsor must follow to ensure longevity of the project.

- **Contact information.** For questions and to submit any correspondence regarding your RTP project, including all required forms and documentation, please use the below contact information:

RTP Planner	573-522-8773 or 573-751-0848
Grants Management Section	mspgrants@dnr.mo.gov
Missouri State Parks	
PO Box 176	
Jefferson City, MO 65102-0176	

SECTION II. NEPA REVIEW AND DETERMINATION

In 1970, the National Environmental Policy Act (NEPA) was signed into law. NEPA established a national environmental policy intentionally focused on federal activities and the desire for a sustainable environment balanced with other essential needs of present and future generations of Americans. Federal agencies have to comply with NEPA before they make final decisions about federal actions that could have environmental effects. Thus, NEPA applies to a very wide range of federal actions that include, but are not limited to, federal construction projects, plans to manage and develop federally owned lands, and federal approvals of non-federal activities such as grants, licenses, and permits.

Because your project has been recommended for RTP funding, you are required to conduct a NEPA review. Most RTP projects typically qualify as Categorical Exclusions (CE) under NEPA (<http://www.fhwa.dot.gov/legsregs/directives/fapg/cfr0771.htm>). CEs are actions that meet the definition contained in 23 CFR §771.117 and, based on experience with similar actions, do not involve significant environmental impacts. They are actions that do not induce significant impacts to planned growth or land use for the area; do not require the relocation of significant numbers of people; do not have a significant impact on any natural, cultural, recreational, historic or other resource; do not involve significant air, noise or water quality impacts; do not have significant impacts on travel patterns; and do not otherwise, either individually or cumulatively, have any significant environmental impacts. An Environmental Assessment (EA) or Environmental Impact Statement (EIS) will be required for a project that does not qualify as a CE. An EA is prepared for actions in which the significance of the environmental impact is not clearly established. If the EA finds a project to have no significant impacts on the environment, a Finding of No Significant Impact (FONSI) is issued. An EIS is prepared for projects where it is known that the action will have a significant effect on the environment. The EIS includes consideration of a range of reasonable alternatives, analyzes the potential impacts resulting from the alternatives, and issues a Record of Decision (ROD). The ROD specifies the environmentally preferable alternative and identifies the commitments that will be implemented to avoid, minimize and compensate for environmental impacts.

In order for GMS and FHWA staff to determine if your project qualifies as a CE, you must complete the NEPA Determination Form found in Appendix A. The form can also be filled out electronically as a fillable PDF available at (<https://mostateparks.com/page/61220/recreational-trails-program-rtp-grants>.) To complete the electronic PDF, you will need Adobe Acrobat Reader, which is available for free download at (<https://get.adobe.com/reader/>.) The NEPA review process requires that you coordinate with other federal and state agencies for their determinations regarding the potential environmental and resource impacts of your project. You must attach determination documentation from these agencies to the NEPA Determination Form in order for GMS and FHWA to establish if your project is classified as a CE under NEPA. If GMS and FHWA concur that your project meets the requirements for a Categorical Exclusion, a Notice to Proceed (NTP) letter will be sent to you. The NTP letter will outline any commitments you are required to incorporate in your project to minimize impacts to the environment and significant resources. If your project does not qualify for a Categorical Exclusion, please contact the GMS to discuss the requirements for completing an Environmental Assessment or Environmental Impact Statement, as appropriate. **Do not begin any phase of your project that requires a NTP letter before receiving that specific NTP letter.**

Please note: Any costs incurred prior to receiving the NTP letter will not be reimbursed; however, some costs incurred prior to receiving NTP may be used as match, such as planning, engineering or environmental review costs (up to 10% of the total grant request). Costs in these categories incurred up to 18 months prior to project approval and notice to proceed may be used as match if the costs were included in your budget table and narrative. Examples of environmental review costs include costs associated with cultural evaluation such as archaeological surveys, environmental approvals, and applicable permits. If you intend to submit a reimbursement request for planning, engineering or environmental review costs and if these costs were identified in your budget table and narrative, contact GMS staff to ensure cost eligibility.

Completing the NEPA Determination Form

The instructions below will assist you in completing the NEPA Determination Form and coordinating with the various federal and state agencies responsible for reviewing your project for impacts. If you have already previously completed all or some of the agency coordination listed below, make sure to still complete the NEPA Determination Form and attach the requisite documentation outlined below. For the Section 106 Review, the determination documentation must be dated within a three-year period of the grant application. Because conditions may change or new information may become available, prior determination documentation for federally- and state-listed threatened and endangered species will only be accepted if generated within 90 days prior to submitting the NEPA Determination Form. New reports will need to be requested if outside this 90-day period.

General Project Information

For *Question 1*, Project Number and Project Title, use the information included on your Financial Assistance Agreement to complete this question. *Questions 2-5* should be completed using the information from your RTP application. *Question 6* addresses projects that are exempt from NEPA review. These consist of projects that do not include construction activities. If your project meets this condition skip to the Certification of Responsible Person section on the form. If in doubt as to whether or not your project meets the exemption category, consult with GMS staff prior to completing the form.

For *Question 7*, provide a brief description of the project scope and identify the physical limits of the review area. Examples of this are: “In this project, we intend to construct 2.3 miles of 8 foot wide and 4 inch thick crushed limestone trail between _ and _ . The environmental review area for this project extends 20 feet in all directions from the centerline of the trail” or “In this project, we propose to improve the North Trailhead of Willow Creek Trail by expanding the parking lot to add 10 additional parking spaces, constructing a pre-cast vault toilet, and installing a wooden informational kiosk. The environmental review area for this project encompasses 21,780 square feet (half an acre), in which the trailhead parking lot and restroom will be constructed.” **Include a map that delineates your project limits and the environmental review area.** Any resources identified within the environmental review area should be noted on the map. Additionally, identify the location and extent of any tree removal that may be required for your project. The environmental review area is the area established around your project within which any impacts to the environment is expected to occur from construction of the project and from any indirect impacts (such as stormwater runoff, construction staging areas, borrow locations, etc.). It is important to identify an area sufficiently large enough to encompass modifications to your project design because very minor design tweaks that occur within the area are very easy to review and environmentally clear versus design modifications that extend beyond your identified environmental review boundary. **If any changes in the project scope, project limits, existing conditions, or pertaining regulations occurs after NEPA has been approved, contact GMS staff immediately, as the determination shall be reevaluated, commensurate with the change, to ensure it is still appropriate.**



Section 106 Review

Questions 8-12 on NEPA Form. Under the National Historic Preservation Act (NHPA), Congress established a comprehensive program to preserve the historical, archaeological and cultural resources of our nation, commonly referred to as Section 106 (now found at 54 USC 306108). Section 106 of NHPA requires federal agencies to consider the effect that their undertaking has on the projects they carry out, approve, or fund. The State Historic Preservation Office (SHPO) is the agency mandated to ensure Section 106 compliance. To initiate a Section 106 Review, submit a Section 106 Project Information Form to SHPO. The form and instructions for completing and submitting the form can be found at (<https://mostateparks.com/page/84261/section->

[106-review.](#)) The form is a fillable PDF requiring Adobe Acrobat Reader, available as a free download from ([https://get.adobe.com/reader/.](https://get.adobe.com/reader/)) You will also be required to submit a 7.5 minute quadrangle map of the site, project plans and photos of any existing structures. To find quadrangle maps, visit the U.S. Geological Survey's National Map website at ([https://store.usgs.gov/.](https://store.usgs.gov/))

INITIATE REVIEW

PLEASE NOTE: If your project represents an "emergency situation" as defined in 36 CFR § 800.12 , please request an expedited review by calling our office at 573-751-7858. Please also be sure to note the emergency status of your project in the "Project Name" field when completing our Review and Compliance Information form.

On Oct. 1, 2022, the Missouri SHPO shifted from its paper-based submission system to an exclusively digital process for the submission of project materials for Section 106 or 110 review. Hard copy submissions will no longer be accepted from this date forward. All submissions should be emailed to MOSection106@dnr.mo.gov and **must** be accompanied by SHPO's [Review and Compliance Information Form](#) . If a cultural resource investigation report is part of the submission, then you **must** also include the cover sheet (Page 1) from the [Cultural Resource Investigation Report Form](#) .

You can find instructions for completing these forms at the following links:

[Instructions for Review and Compliance Information Form](#) 

[Instructions for Cultural Resource Investigation Report Form](#) 

A recording of our Webex training session on navigating the digital submission process can be viewed by [clicking here](#).

The department uses PDF fillable forms. You will be able to save and reuse these forms; however, you will need [Adobe Acrobat Reader 7](#) or higher to save the forms.



If the information you provided is sufficient to make a determination, SHPO will send you a Cultural Resource Assessment that will indicate the presence of historic properties and effect. Indicate the finding on the NEPA Determination Form and attach a copy of the Cultural Resource Assessment to the form. If the information you submitted is not sufficient to make a determination, SHPO will send you a letter requesting additional information or may require that a cultural or archaeology survey be conducted by a professional archaeologist or architectural historian. Coordinate with GMS and SHPO on the requirements of the survey and completing a Section 106 Survey Memo Form. Once the survey has been completed and reviewed by SHPO, indicate the determination results from the survey on the NEPA form, and attach the concurrence letter from SHPO along with the survey. If your project has an adverse effect determination, further consultation between SHPO, GMS and FHWA is required. A Memorandum of Agreement (MOA) between your organization, FHWA, GMS and SHPO may be required, outlining avoidance or mitigation measures. Attach a copy of any coordination correspondence, including a MOA if required, to the form. List any commitments required by SHPO for avoiding, minimizing, or mitigating resource damage or, if these measures are outlined in a MOA, indicate, "See attached MOA" in the space provided. The Section 106 Review must be satisfactorily completed before the NEPA Determination Form can be approved, which means that an effect determination must be made and a MOA executed (if necessary). Environmental review laws require FHWA to consult with all interested

federally recognized tribes who have an interest in Missouri, which may require evaluation of historic or archeological survey within the area of potential effects for the project. GMS will provide FHWA with all information you submit with your NEPA review packet. If surveys are not performed or provided but need to be evaluated, FHWA may require the project sponsor to provide the information to FHWA before a notice to proceed can be issued. Survey costs are an eligible cost for reimbursement.

Threatened and Endangered Species

Questions 13-14 on NEPA Form. The Endangered Species Act (ESA) requires that federal agencies, in consultation with the U.S. Fish and Wildlife Service (USFWS), ensure that any actions they fund, authorize, or carry out will not jeopardize the continued existence of federally-listed threatened or endangered (T&E) species or destroy or adversely modify designated habitat critical to those species. For the ESA, the following effect determinations are made: “No Effect,” “May Affect, Not Likely to Adversely Affect,” and “May Affect, Likely to Adversely Affect.” To evaluate the project’s impact to federally-listed T&E species or their habitat, use the USFWS’s Information for Planning and Conservation (IPaC) search tool to request an official species list of T&E species and the presence of critical habitat that should be considered when evaluating the potential impacts of your project. The IPaC search tool can be found at (<https://ipac.ecosphere.fws.gov/>) and will require you to create a free account, enter information about your project and delineate your project’s boundaries on an online map. You will need to request an Official Species List, which will be generated automatically as a PDF and will require you to download it from the website. Attach a copy of the official species list to the NEPA Determination Form. The screenshots below outline the steps to take to generate your project site’s T&E species list.

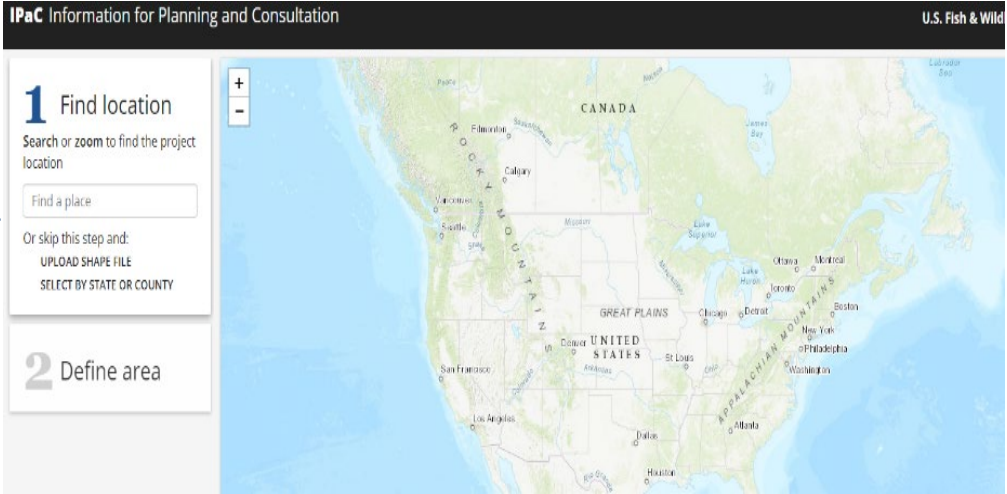
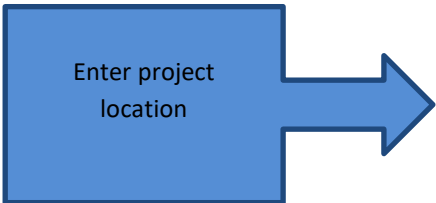
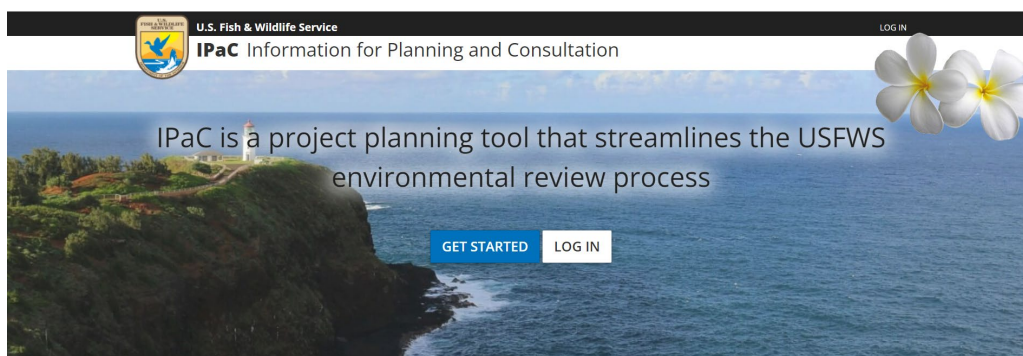

1 Find location

2 Define area

Draw the area where activities will occur

Select a drawing tool

SKETCH

POLYGON

LINE

Other options:

UPLOAD SHAPE FILE

SELECT BY STATE OR COUNTY



Zoom in closer to the location. Click "Polygon" and draw the project area. Remember to define the review area sufficiently large enough to account for any direct or indirect resource impacts and to accommodate for potential future modifications to the project footprint.

1 Find location

2 Define area

Draw the area where activities will occur

Click finished drawing when done drawing the polygon

AREA: 32.33 acres

FINISHED DRAWING

UNDO LAST POINT



Click "Finished Drawing"

1 Find location

2 Define area

3 Confirm

Verify the area where project activities will occur

Modify the shape by clicking and dragging the vertices or clicking on a solid vertex to remove it

LENGTH: 1.02 miles

WIDTH: 100 ft

CONTINUE

START OVER



Click "Continue"

IPaC Information for Planning and Consultation

Resources

ENDANGERED SPECIES	6
MIGRATORY BIRDS	5
FACILITIES	
WETLANDS	!

[PRINT RESOURCE LIST](#)

What's next?

Define a project at this location to evaluate potential impacts, get an official species list, and make species determinations.

[DEFINE PROJECT](#)

Endangered spec

Listed species (1) and their critical habitat (2) under the Endangered Species Act (ESA) are managed by the U.S. Fish and Wildlife Service (USFWS) and the U.S. Environmental Protection Agency (EPA). Please contact [NOAA Fisheries](#) for species and critical habitats under the ESA. Additional information on endangered species is available at [NOAA Fisheries](#). The following species are potentially affected by this project:

[THUMBNAILS](#) [LIST](#)

Mammals

Endangered



Click "Define Project"

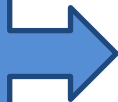

You will be asked to log in or create an IPaC account.



Log in ✕

LOGIN.GOV LOGIN
You can use your Login.gov profile as your IPaC account. You will need to allow IPaC to read your basic profile information.

[LOG IN WITH LOGIN.GOV](#)

IPaC LOGIN

[Why do I need an IPaC account?](#)

Notice
By logging into this agency computer system, you acknowledge and consent to the monitoring of this system. Evidence of your use, authorized or unauthorized, collected during monitoring may be used for civil, criminal, administrative, or other adverse action. Unauthorized or illegal use may subject you to prosecution.

This computer system, including all related equipment, networks, and network devices (including internet access), is provided by the Department of the Interior (DOI) in accordance with the agency policy for official use and limited personal use.

All agency computer systems may be monitored for all lawful purposes, including but not limited to, ensuring that use is authorized, for management of the system, to facilitate protection against unauthorized access, and to verify security procedures, survivability and operational security. Any information on this computer system may be examined, recorded, copied and used for authorized purposes at any time.

All information, including personal information, placed or sent over this system may be monitored, and users of this system are reminded that such monitoring does occur. Therefore, there should be no expectation of privacy with respect to use of this system.

Enter information and click "Save"



Define project

Define a project at this location to evaluate potential impacts, get an official species list, and make species determinations.

Project name

Project description
Describe the location, size, scope, and timing of this project. OPTIONAL

[SAVE](#) [CANCEL](#)

Test

No description provided.



LOCATION Cole County, Missouri
 CREATED September 29, 2021

What's next?

ESA REVIEW
 Review this project's effects on listed species pursuant to the Endangered Species Act (ESA), as part of the overall regulatory review.

START REVIEW

SPECIES LIST
 Requesting an official species list is now part of IPaC's ESA Review.

REQUEST SPECIES LIST

This page provides an overview of the area. Click on "Start Review."

Endangered Species Act Review

EXIT REVIEW

Step-by-step consultation process

The Endangered Species Act (ESA) Review in IPaC is a streamlined, step-by-step consultation process. The steps below prepare you for consultation with the U.S. Fish and Wildlife Service or provide official documentation if consultation is not necessary.

- 1 Request an official species list
 An official species list must be requested for projects conducted, permitted, funded, or licensed by a Federal agency. Projects unaffiliated with a Federal agency may skip this step.
- 2 Evaluate determination keys
 Determination keys are up-front analyses from the U.S. Fish and Wildlife Service that streamline the consultation process for common project types. Each determination key starts with a qualification interview to see if the key is appropriate for your project.
- 3 Evaluate effects to remaining species through the Consultation Package Builder
 When you have listed species in your project area that have not been addressed by a determination key, IPaC's project analysis tool is used to further analyze your project. The process assists you in making effect determinations and results in a document (i.e., Biological Assessment or other environmental review document) that can be submitted to the U.S. Fish and Wildlife Service for consultation.
- 4 Finalize your consultation package
 Print your project documents to PDF.

For more information about the consultation process, see an overview of Section 7.

CONTINUE

Click "Continue"

Endangered Species Act Review

← BACK EXIT REVIEW

- 1 Request an official species list
- 2 Evaluate determination keys
- 3 Analyze project (optional)
- 4 Download documentation

Step 1: Request an official species list

An official species list is a letter from the local U.S. Fish and Wildlife Service field office that assists in the evaluation of potential impacts of your project. It includes a list of species that should be considered under [Section 7](#) of the Endangered Species Act, a project tracking number, and other pertinent information from the field office.

Does this project require an official species list?

Federal agencies are required to "request of the Secretary of Interior information whether any species which is listed or proposed to be listed may be present in the area of a proposed action" ([Section 7](#) of the Endangered Species Act).

This requirement applies to projects that are conducted, permitted, funded, or licensed by any Federal agency.

YES, REQUEST A SPECIES LIST SKIP / DOES NOT APPLY

Click "Yes, Request a Species List"



Is this project being conducted, permitted, funded, or licensed by a Federal agency?

Yes

CHANGE ANSWER

Does your project fall under (or receive funding through) any of the following special project authorities? (select all that apply)

FAST-41

BIPARTISAN INFRASTRUCTURE LAW (BIL) (OTHER)

INFLATION REDUCTION ACT (IRA) (OTHER)

BLM OIL AND GAS PROGRAM (SECTION 365)

BLM RENEWABLE ENERGY PROGRAM (SECTION 3102)

FOREST SERVICE WILDFIRE (BIL 40803/40804)

DOI WILDFIRE (BIL 40803)

FEDERAL PERMITTING IMPROVEMENT STEERING COUNCIL (FPISC) TRANSPARENCY PROJECT

IRA (SECTION 50303)

NONE

What kind of organization are you working for directly?

State Agency

Click "Yes" the project is being funded by a Federal Agency. For the question "Does your project fall under..." choose "Bipartisan Infrastructure Law." Choose the type of organization that you are.



Who is the Lead Federal Agency for this project?

This would be the agency responsible for conducting, permitting, licensing, or funding this action

There is another agency that is the lead agency

Are you a designated non-federal representative?

No

CHANGE ANSWER

What is your role in this project?

Applicant

In which state is your agency located?

Missouri

Select your city agency

For the Federal Agency click "There is another agency that is the lead agency." Click "No" you are not a designated non-federal representative." Click "applicant" for your role in the project. Select the city agency you work for.



Tell us about the lead agency for the project

What kind of organization is the lead agency for this project?

Federal Agency

Who is the lead agency?

Federal Highway Administration

Federal Highway Administration

For the question "What kind of organization..." click "Federal Agency." The lead agency is the "Federal Highway Administration."



Full name

Aidan Dickneite

Street address

1659 E Elm St.

OPTIONAL

City

Jefferson City

State

MO

Zip

65101

Email

aidan.dickneite@dnr.mo.gov

Enter personnel information.



Enter your project information

Project name

RTP Project Sample

Project description

Lewis & Clark Building

Select your project type

Recreation - Maintenance / Modification

Recreation - Maintenance / Modification

Location

Enter in "Project Name, Project Description, and select "Recreation Maintenance/ Modification or Recreation New Construction." Whichever project type is appropriate for the project.

Location



Click "Submit Official Species List Request."

SUBMIT OFFICIAL SPECIES LIST REQUEST

Endangered Species Act Review

◀ BACK EXIT REVIEW ▶

- 1 Request an official species list
- 2 Evaluate Determination Keys
- 3 Analyze project (optional)
- 4 Download documentation

Step 1: Request an official species list

An official species list is a letter from the local U.S. Fish and Wildlife Service field office that assists in the evaluation of potential impacts of your project. It includes a list of species that should be considered under [Section 7](#) of the Endangered Species Act, a project tracking number, and other pertinent information from the field office.

Species list request complete

This species list was generated [about a minute ago](#). Species lists are considered valid for 90 days.

An official species list has been generated for the following office.

 [Species List: Missouri Ecological Services Field Office](#)

This document is also available on the [Documents](#) page.



REQUEST UPDATED SPECIES LIST **NEXT STEP: DETERMINATION KEYS**

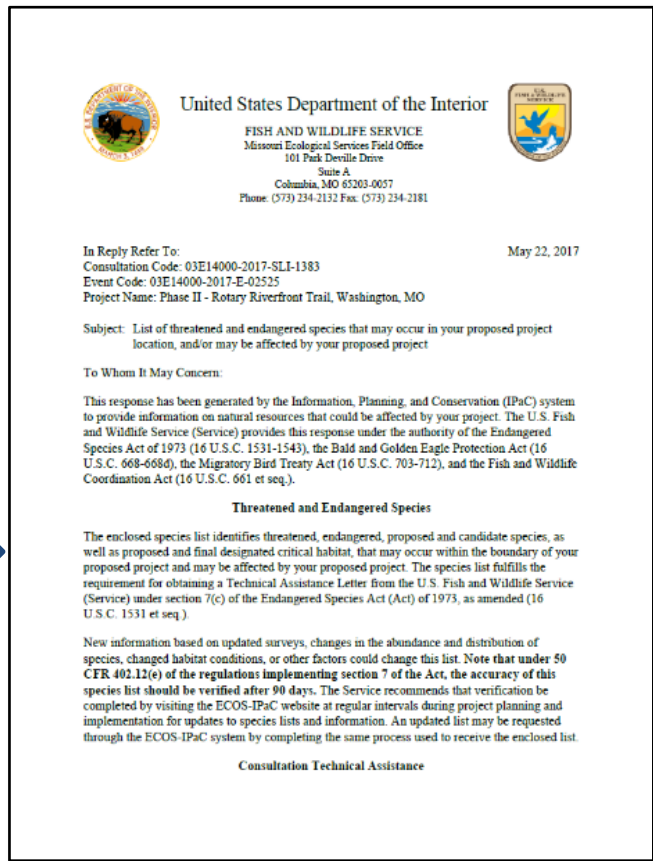
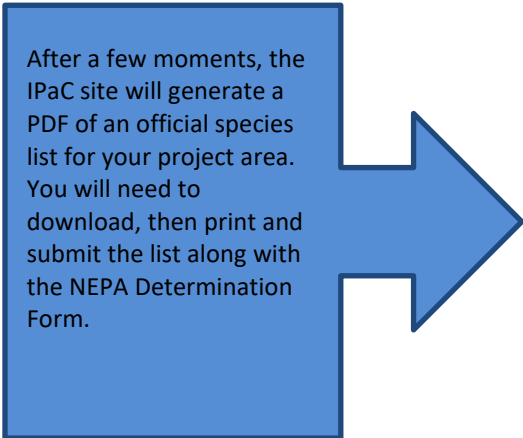

In addition to determining your project’s impact on federally listed T&E species, you must also determine its impact on state-listed endangered species or species and habitats of conservation concern by entering your information into the Missouri Natural Heritage Review Website (<https://naturalheritagereview.mdc.mo.gov/>). You will need to follow the website’s instructions for creating a user login and password, and for entering your project information and project boundary. The Missouri Department of Conservation (MDC) will email you a Natural Heritage Review Report, which must also be attached to the NEPA Determination Form. The below screen shots outline the steps needed for this process.

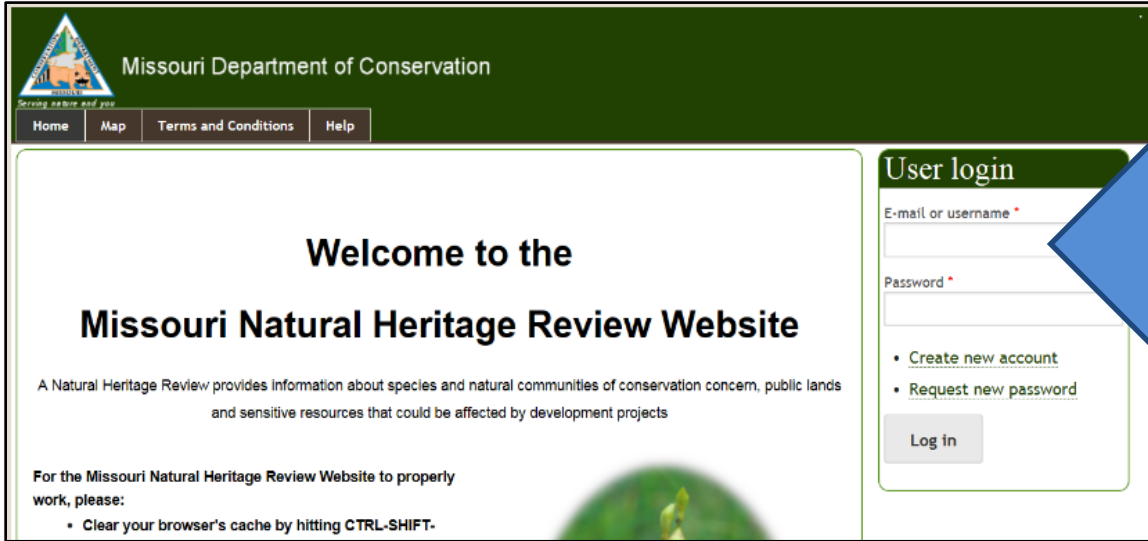

Click the “Map” tab.

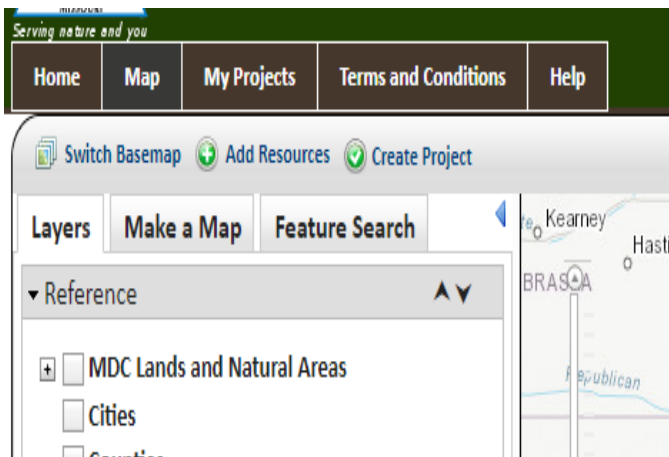

Click “Create Project”

Remember to define the review area sufficiently large enough to account for any direct or indirect resource impacts and to accommodate for potential future modifications to the project footprint.

Draw project area. When done, click "Accept."

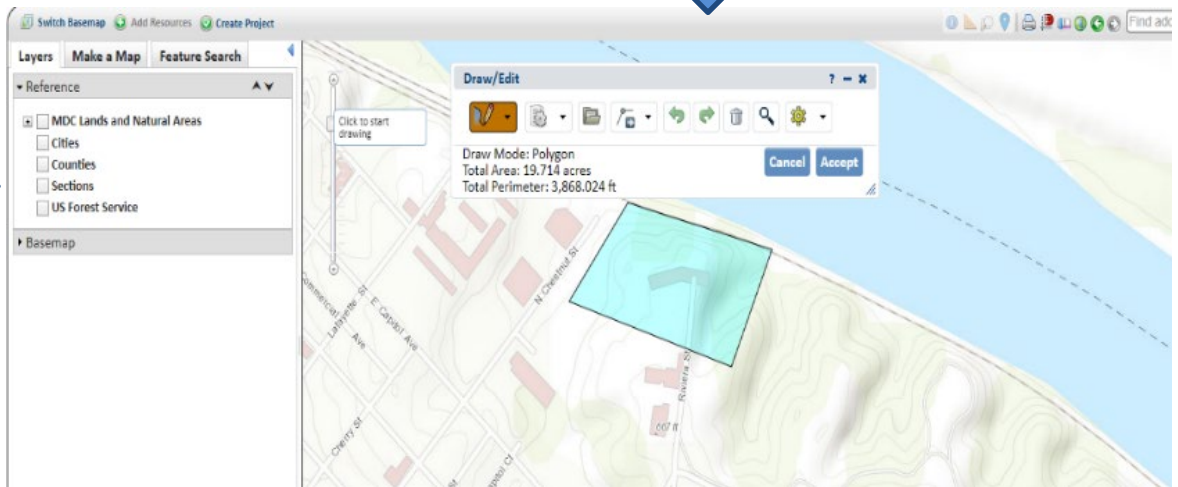

Create Project

Fields marked with red asterisks are required fields.

Project Title *

Enter a descriptive and brief title for this project.

User Project Number(s)

Organization-specific project number(s) for user tracking purposes (optional)

Project Type *

Select only one Project Type per project

Communication Antennas, Towers, Lines and other Structures, including Access Roads

Confined Animal Feeding Operations

Energy Storage, Production and Transfer

Habitat Conservation and Restoration

Hazardous Waste Clean-up, Site Remediation, and Reclamation

In-stream / Riverine Activities and Projects

Mining

Recreation

Residential, Commercial and Governmental Building Development

Transportation

Waste Transfer, Treatment, and Disposal

Enter a "Project Title." Under "Project Type," expand the "Recreation" box and then expand the "Trails & Trailheads" box. Indicate whether your project is construction of new facilities or maintenance of existing facilities.

Create Project

Project Description *
Please include TRS, lat/long, River/Stream Name, and County.
Jefferson City, MO RTP Project Test

On Behalf Of
- None -

Contact Name *
Aidan Dickneite

Organization *
DNR - Missouri State Parks

Email *
aidan.dickneite@dnr.mo.gov

Phone number *
573-522-8773

Address *
1659 E Elm St.

Address line 2

Enter a "Project Description" and the project contact information.

Project Edit Status *
Select Final when your project is ready for Formal Departmental Review.
Final

File attachments

Add a new file
Attach supporting documentation here. Please note: Files added to the project are not permanent until you save or submit this page. For multiple attachments, this is a two-step process; first Choose the File and then Upload it to be able to select another file.

Choose File No file chosen

Upload

Files must be less than 5 MB each.
Allowed file types: doc jpg jpeg gif png txt doc xls pdf ppt pps odt ods odp docx xlsx zip kml kmz.

Submit Cancel

Enter "Project Status as Final" and upload supporting documents. Click "Submit."

Confirmation

Thank you for submitting your project for review. A notification email will be sent once the automated review is complete. Depending on system load, this may take up to 5 minutes. You may check Review Status by clicking on the Project Title under My Projects tab.

OK

A confirmation message will appear. Click "Ok." Once receiving the email, follow the link to retrieve the report.

RTP Test Project

[View](#) [Edit/View Shape](#) [Generate Report](#)

Project Review Results

Revision date	Report Status	Report File	Boundary Shapefile	KMZ File
7/18/2022 10:12:44 AM	Generated	Project Report (PDF)	Shapefile (ZIP)	Generate KMZ

Submitted by aidan.dickneite_5725 on Mon, 07/18/2022 - 10:11
Project ID: 11180

Project Type:

- Recreation
 - Trails & Trailheads (parking, etc.)
 - Construction of new facilities

Click "Project Report PDF." Download the report and include the information and report with the NEPA form.



Missouri Department of Conservation
Missouri Department of Conservation's Mission is to protect and manage the forest, fish, and wildlife resources of the state and to facilitate and provide opportunities for all citizens to use, enjoy and learn about these resources.

Natural Heritage Review Level Three Report: Species Listed Under the Federal Endangered Species Act

There are records for species listed under the Federal Endangered Species Act, and possibly also records for species listed Endangered by the state, or Missouri Species and/or Natural Communities of Conservation Concern within or near the the defined Project Area. Please contact the U.S. Fish and Wildlife Service and the Missouri Department of Conservation for further coordination.

Foreword: Thank you for accessing the Missouri Natural Heritage Review Website developed by the Missouri Department of Conservation with assistance from the U.S. Fish and Wildlife Service, the U.S. Army Corps of Engineers, Missouri Department of Transportation and NatureServe. The purpose of this website is to provide information to federal, state and local agencies, organizations, municipalities, corporations and consultants regarding sensitive fish, wildlife, plants, natural communities and habitats to assist in planning, designing and permitting stages of projects.

PROJECT INFORMATION

Project Name and ID Number: Phase II - Rotary Riverfront Trail #1546

Project Description: The City of Washington is applying for a Recreational Trails Program (RTP) grant to construct an approx. 1-mile, 12' wide, asphalt trail that would parallel the Missouri River for about two-thirds of the way, traversing around wetlands. The parcels on which the trail will be built total approx. 42 acres. The City has conducted a wetland and waterbody delineation study, which identified the presence of a forested/emergent/scrub-shrub wetland complex dominating the southeastern two thirds of the project site and a scrub-shrub wetland complex on the northern corner of the site. The City has coordinated with the US Army Corps of Engineers and has been granted a 5-year jurisdictional determination. The City intends to implement a vegetative management plan to establish native vegetation appropriate to the Missouri River bottomland forest/wetland landscape. If recommended for funding, the City would have six months to complete a NEPA review, so the earliest anticipated start date would be March 2017. The City would be required to have the project completed by September 2019. The project site is located 38.563904, -91.017449, in Franklin Co.

Project Type: Recreation, Trails & Trailheads (parking, etc.), Construction of new facilities

Contact Person: Dawn Fredrickson

Contact Information: dawn.fredrickson@dnr.mo.gov or 573-751-0848

Missouri Department of Conservation Page 1 of 5 Report Created: 7/20/2016 04:53:59 PM

After identifying the species and critical habitats listed on the Official Species List and Natural Heritage Report that have potential to be located in your project area, you must conduct an evaluation to determine if your project may impact those species or their habitats. It is highly recommended that you hire a professional environmental consultant to conduct the evaluation. You must indicate on the NEPA Determination Form whether or not impacts are anticipated and you must summarize your project impacts, for each species listed.

- If impacts are anticipated, you will need to describe what activities will likely cause impact and to what extent.
 - For instance, if your project will require tree removal, please indicate the magnitude of the tree removal (i.e., acreage or number of trees) and the time of year for tree-clearing.
 - Make sure the location and anticipated footprint of tree removal is identified on your Environmental Review Area Map.
 - Attach photos of the trees so that bark characteristics of the main trunk and large branches, along with any cavities, are clearly illustrated.
 - If your project requires the renovation or replacement of a bridge, attach photos of the undersides of the bridge illustrating any bird nests or unusual staining on the substructure or underside of the decking.
- You must then describe any commitments you will undertake to avoid and minimize any potential impact to listed species. For instance, a commitment to only remove trees between November and March.
- If no impacts are anticipated for a particular species, you will need to provide reasons why none are anticipated, such as, “This project does not involve any tree clearing, so there will be no effects on summer roosting habitat for listed bat species;” or “This project does not impact any aquatic habitats so there will be no effects on listed fish or mussel species;” or “This project does not impact the Missouri or Mississippi rivers so there will be no effects on pallid sturgeon.”

If the project “may affect” threatened and endangered species, GMS staff will review the information you provide and work with FHWA to internally consult with USFWS for concurrence with a “May Affect, Not Likely to Adversely Affect” determination. Once the USFWS concurrence letter is received, GMS will summarize any commitments required by the USFWS to be incorporated in your project and will attach them to the NEPA Determination Form, and will provide you a copy. If there is a “May Affect, Likely to Adversely Affect” determination made, a Biological Assessment will then need to be prepared and formal consultation with the USFWS, through FHWA and the Department, will need to occur. GMS staff will contact you if this latter instance transpires. Coordination with the USFWS must be completed for projects having anything other than a “no effect” determination, before the NEPA Determination Form is approved.

Section 6(f)(3) Lands

Question 15-17 on NEPA Form. Parks or other lands that were funded by the Land and Water Conservation Fund (LWCF) are federally protected in perpetuity under Section 6(f)(3) of the Land and Water Conservation Fund Act. For assistance in determining if your project is located on 6(f)(3)-protected property, contact GMS staff. If it is determined that your project is located on property protected under Section 6(f)(3), GMS staff will review your project to determine if negative impacts will result from your project and what measures you will be required to take to avoid or mitigate resource impacts. Attach a copy of GMS’ determination letter to the NEPA Determination Form and include any commitment requirements from the letter in the space provided in question 17.

Impacts to Jurisdictional Waters

Question 18-21 on NEPA Form. Section 404 of the Clean Water Act (CWA) regulates the discharge of dredged or fill material into jurisdictional waters of the United States. Jurisdictional waters include large lakes, rivers, streams and wetlands, including those that don’t always contain water. Activities in jurisdictional waters of the United States regulated under this program include fill for development, water resource projects (such as dams and levees), and infrastructure development. Some specific examples of construction activities that would require permitting include placing culverts under road crossings, placing rip rap along stream banks and installing stormwater outfall pipes. Section 404 requires a federal permit before dredged or fill material may be discharged into waters of the United States, unless the activity is exempt from Section 404 regulation (e.g. certain farming and forestry activities). A state-issued 401 Water Quality Certification (401 Certification) is also needed for any project that needs a federal 404 Permit. The permitting and certification process is shared between the U.S. Army Corps of Engineers (USACE) and the Missouri Department of Natural Resources (Department).

In order to determine if your project will require a 404 Permit and a 401 Certification, you will need to establish if any of the following are in your environmental review area:

- Creek or stream channel (even if the bed is currently dry)
- Lake
- River
- Drainage ditch

- Wetlands – if you’re unsure if your project contains wetlands, look for these indicators: an area that often has standing water; a low spot that holds water for several days after it rains; the water table in the area is not far from the surface; the area is near a river, lake or pond; or the area contains plants more typical of a wetland, such as cattails, rushes and sedges. A useful tool for identifying potential wetlands is the Wetlands Mapper, provided through the National Wetlands Inventory (<https://www.fws.gov/program/national-wetlands-inventory/wetlands-mapper>.)

Scroll to the bottom of the page and click “Wetlands Mapper.”

3 Open any Mapper by clicking on the map icons below (best viewed by maximizing your browser window):

Wetlands Mapper

NWI data desktop/mobile viewer; data last modified May 1, 2021.



Projects Mapper

Recent wetland data additions and active wetland mapping projects.



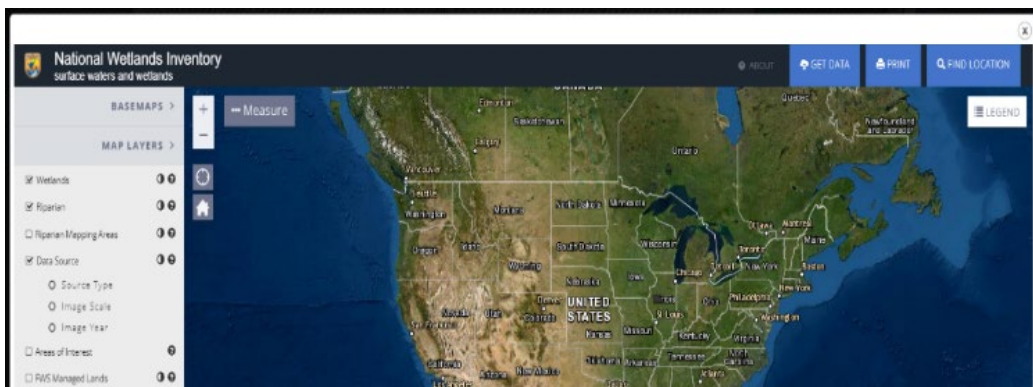

Click “Find Location” enter project location and click “Go.”



Click “Print”

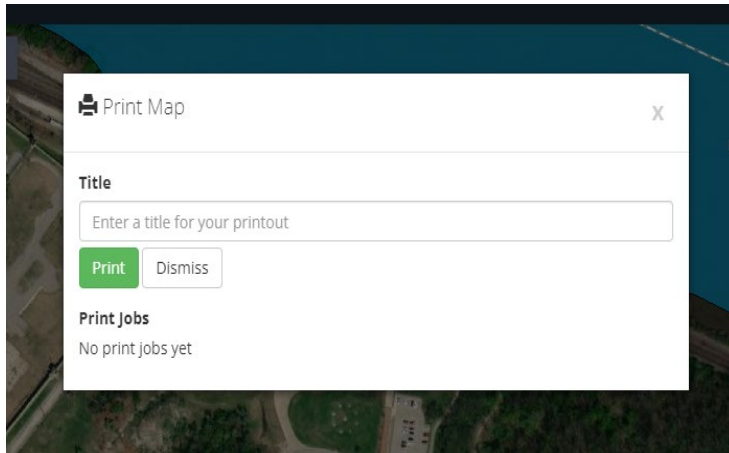

Enter "Title" and click "Print." A map will be generated, download the PDF and attach to NEPA Form.

If any of the listed conditions exist within your project area, then you will need to determine if your project has the potential to impact any jurisdictional water. Project sponsors are strongly encouraged to hire or consult with a professional who is qualified to identify wetlands and other jurisdictional waters to determine if the project will have an impact on those resources. Many activities involving relatively minor impacts are authorized under Nationwide Permits, or NWPs. To find out if your project falls under a NWP, you will need to contact the USACE District Office that oversees the district in which your project is located. A map of Missouri's USACE districts is available here:

(https://www.mvm.usace.army.mil/portals/51/docs/regulatory/boundary%20maps/missouri_regulatory_offices.pdf.) The USACE will indicate whether your project is covered under a NWP or if you will be required to complete an individual 404 permit application (<http://www.usace.army.mil/Missions/Civil-Works/Regulatory-Program-and-Permits/Obtain-a-Permit/>). The USACE will then send you a letter authorizing your project under a particular permit and will send a copy of your letter to the Department. If the USACE's letter to you indicates that the Department has "conditionally certified" your activity and the letter includes the Department's conditions, you will not need to contact the Department for further certification. If the USACE's letter to you indicates that you must obtain an individual 401 certification, please follow the instructions for submitting your application materials to the Department, which can be found at (<https://dnr.mo.gov/water/business-industry-other-entities/permits-certification-engineering-fees/section-401-water-quality>.)

If the USACE and/or the Department determine that there will be impacts to jurisdictional waters and/or wetlands, please indicate on the NEPA Determination Form the extent of the impact (i.e., acreage of non-wetland jurisdictional waters impacted, acreage of wetland jurisdictional waters impacted). Indicate the 404/401 permit type that is anticipated or has been acquired and any conditions of the 404/401 permit. If the permit is not yet in-hand, include a commitment to follow the conditions of the permit. Submit a copy of the permit to GMS, once obtained.

Water Quality Impacts

Question 22-27 on NEPA Form. The Missouri Department of Natural Resources' Water Protection Program (WPP) implements the National Pollutant Discharge Elimination System (NPDES) Program, including permitting, administrative, and enforcement, as outlined in Section 402 of the federal Clean Water Act. The Department requires a Land Disturbance Permit for projects that disturb one or more acres or disturb less than one acre when part of a larger common plan of development that will disturb a cumulative total of one or more acres over the life of the project. A permit must be obtained and a Stormwater Pollution Prevention Plan written prior to starting land disturbance activities.

For your convenience, the Department has created the ePermitting system to allow you to apply for your Land Disturbance Permit online (<http://dnr.mo.gov/env/wpp/epermit/help.htm>.) To log onto ePermitting, you must enter through the Department's Missouri Gateway for Environmental Management (MoGEM) (<https://dnr.mo.gov/mogem/>.) This page also has guidance on how to register, as well as a frequently asked questions.

For assistance regarding ePermitting, contact ePermitting Assistance Hotline at 573-526-2082 or 855-789-3889 or by email at (epermitting@dnr.mo.gov) during regular business hours.

On the NEPA Determination Form, indicate if your project will disturb one acre or more. Indicate if there are any of the following within the environmental review area: wells, sinkholes, sensitive streams, springs or caves. Describe how your project may impact these areas. If no impacts are anticipated, indicate how you made that determination. If your project will disturb an

acre or more and you've applied for a land disturbance permit, list the conditions of the permit or, if the permit is not yet in-hand, include a commitment to obtain the permit prior to construction and to follow the conditions of the permit. Submit a copy of the permit to GMS, once obtained.

Floodplain Impacts

Question 28-31 on NEPA Form. Communities (cities, counties, or states) participating in the National Flood Insurance Program (NFIP) are required to regulate construction in the floodplain. Communities accomplish this by requiring permits for development in special flood hazard areas.

Additionally, the Federal Emergency Management Agency (FEMA) has mandated that any project in a floodplain must be reviewed to determine if the project will increase flood heights. FEMA defines a floodplain as any land area susceptible to being inundated by water. The 100-year flood, or a flood with a one percent annual chance of being equaled or exceeded in a given year, has been adopted by FEMA as the base (regulatory) flood for the NFIP. The water surface elevation of the base flood is known as the base flood elevation. A special flood hazard area is land in the floodplain inundated by the 100-year flood and is commonly referred to as the "100-year floodplain." A floodplain development permit is required for any construction in a special flood hazard area. Special flood hazard areas are typically shown as "A zones" on flood insurance maps.

To determine if your project is in a floodplain or special flood hazard area, use the FEMA Flood Map Service Center (<https://msc.fema.gov/portal>). If you determine your project is within a floodplain or special flood hazard area, you must obtain a floodplain development permit from the local floodplain authority (i.e., community or county). For a list of communities and counties participating in the NFIP, see (<https://www.fema.gov/cis/MO.html>.) In some instances, a No-Rise Certification may be required by the community or county before a permit is issued. On the NEPA Determination Form, indicate if your project is in a floodplain or special flood hazard area and submit a copy of the floodplain map for your project area. If a permit is required, and it is already obtained, state the name of the permit and attach a copy. List the commitments required by the permit or, if the permit is not yet in-hand, include a commitment to obtain the permit prior to construction and to follow the conditions of the permit.



FEMA Flood Map Service Center: Welcome!

Navigation

Search

Languages

MSC Home

MSC Search by Address

MSC Search All Products

Looking for a Flood Map?

Enter an address, a place, or longitude/latitude coordinates:

Looking for more than just a current flood map?

Visit [Search All Products](#) to access the full range of flood risk products for your community.

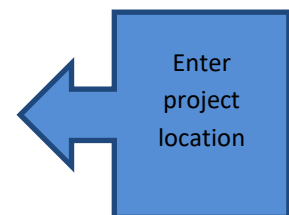

FEMA Flood Map Service Center: Search By Address

Enter an address, place, or coordinates: ?

1101 riverside drive jefferson city mo Search

 Whether you are in a high risk zone or not, you may need [flood insurance](#) because most homeowners insurance doesn't cover flood damage. If you live in an area with low or moderate flood risk, you are 5 times more likely to experience flood than a fire in your home over the next 30 years. For many, a National Flood Insurance Program's flood insurance policy could cost less than \$400 per year. Call your insurance agent today and protect what you've built.

[Learn more about steps you can take](#) to reduce flood risk damage.

Search Results—Products for **JEFFERSON CITY, CITY OF**

[Show ALL Products »](#)

The flood map for the selected area is number **29051C0134E**, effective on **11/02/2012** ?



DYNAMIC MAP



MAP IMAGE



Changes to this FIRM ?

-  Revisions (0)
-  Amendments (2)
-  Revalidations (0)

Your map will appear in a few moments. Make sure that the map includes the project area. Click “Dynamic Map” to download and print for the NEPA form.

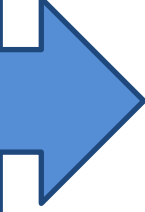
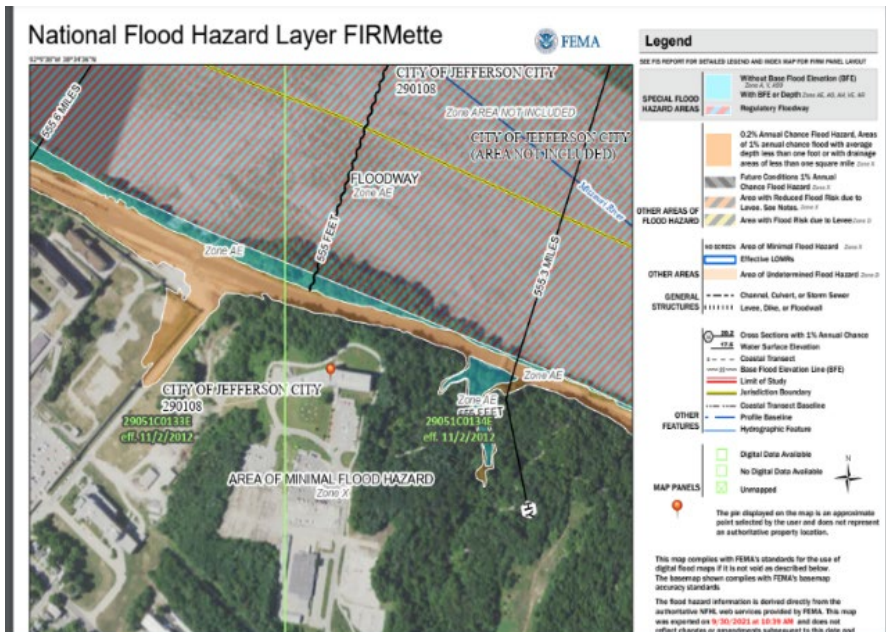
Sample Floodplain Map

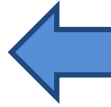

Air Quality

Question 33-37 on NEPA Form. The Clean Air Act (CAA) is the federal law that regulates air emissions. Among other things, this law authorizes EPA to establish National Ambient Air Quality Standards (NAAQS) to protect public health and public welfare and to regulate emissions of hazardous air pollutants. Most RTP projects and project-related activities are exempt from air quality conformity requirements of the CAA, unless the project is considered “regionally significant” as defined by 23 CFR 450.104 (<https://www.ecfr.gov/current/title-23/chapter-I/subchapter-E/part-450>) or is located in a nonattainment area. Projects outside the St. Louis and Kansas City Metropolitan Planning Organization (MPO) areas generally will not meet the definition of “regionally significant.” For projects within the St. Louis and Kansas City MPO areas, the project sponsor will need to coordinate with the MPO to determine the level of analysis required. For MPO contact information, see (<http://www.fhwa.dot.gov/modiv/programs/mpo.cfm>.) If a project is determined to be regionally significant, conformity will be demonstrated through an established process for inclusion in a metropolitan Transportation Improvement Program (TIP). Indicate on the NEPA Determination Form if your project is in either the St. Louis or Kansas City MPO and provide documentation that you’ve coordinated with the MPO in determining if your project is considered regionally significant.

Air quality standards also regulate open burning. Open burning of tree trunks, tree limbs and vegetation from land clearing operations is allowed without a permit if untreated and done in accordance with state regulations. For information about those requirements, please go to the Department’s website (<https://dnr.mo.gov/document-search/facts-open-burning-under-missouri-regulations-pub2047/pub2047>.) Local jurisdictions (i.e., municipalities, counties, etc.) may have additional restrictions on open burning. Prior to conducting any open burning, the project sponsor should contact the city or county of jurisdiction for any local restrictions or required permits. If a permit is required, and it is already obtained, attach a copy. List the commitments required by the permit or, if the permit is not yet in-hand, include a commitment to obtain the permit prior to construction and to follow the conditions of the permit.

Hazardous Waste

Question 38-42 on NEPA Form. Hazardous waste is waste that poses substantial or potential threats to public health or the environment. A site assessment of your project area must be completed to determine the presence of hazardous waste materials on-site or adjacent to the project boundaries. Project sponsors are strongly encouraged to consult a professional who is qualified to identify hazardous substances or determine the likelihood of their being present in and around the project site, especially if previous land uses at or near the project site were industrial or commercial in nature. Key indicators that may indicate the presence of hazardous waste include stained or discolored soil; dead or dying vegetation; drums or containers containing unknown substances; or piles of waste materials that include batteries or transformers. Additionally, if your project requires the renovation or demolition of a structure that was built before 1976, it may contain asbestos or lead-based paint.

To assist you with determining the potential for hazardous substances at or adjacent to your project site, the Department has provided Missouri E-START, an online map of hazardous waste and petroleum storage sites (https://apps5.mo.gov/ESTARTMAP/map/init_map.action). Once you’ve identified the location of your project area on the map, print off a copy of the map and submit it with the NEPA Determination Form. On the NEPA Determination Form, indicate if there are any known hazardous waste sites in the environmental review area and whether or not your project will impact any of these sites. If there will be impacts, provide a description of what those impacts will be. If potential hazardous materials are encountered during construction activities at the project site, all work must cease immediately until a hazardous materials expert has reviewed the location and completed any necessary coordination and remediation. In the event hazardous materials are encountered, you must immediately contact the Department’s Regional Office in your area (<https://intranet.state.mo.us/dnr/regional-office-maps/>) as well as GMS staff. By marking the Question 42 box next to the commitment statement on the NEPA Determination Form, you are agreeing to comply with this requirement. All project sponsors must check this box, regardless of whether or not hazardous materials are suspected of being present within the environmental review area.

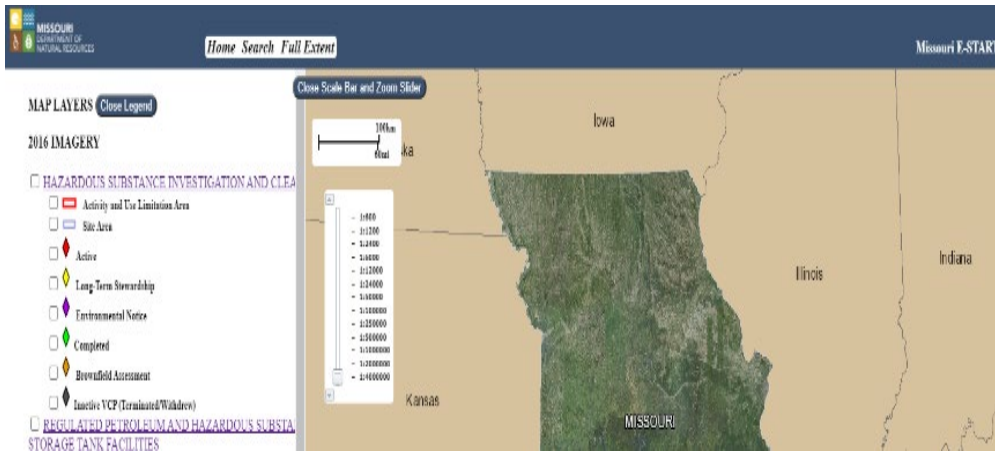

Click "Search" and enter project location

In the legend select "Hazardous Substance Investigation" and "Regulated Petroleum & Hazardous." Print off a copy to include with the NEPA form.

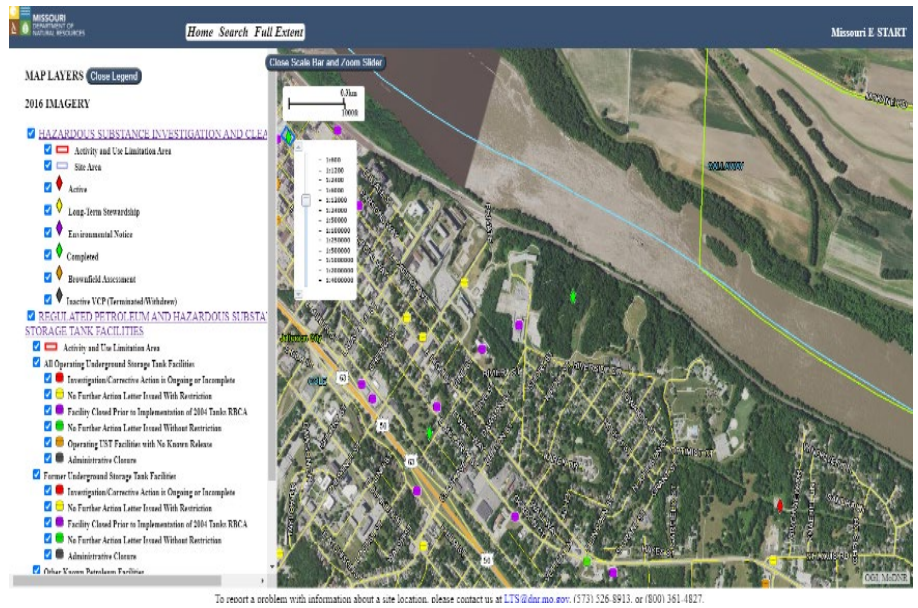

If you suspect that your project site may have contaminants, the Department’s Hazardous Waste Program offers a Brownfields/Voluntary Cleanup Program (BVCP) under a cooperative agreement with the EPA to conduct brownfield assessments of properties for public entities such as cities, counties and quasi-governmental entities, as well as for not-for-profit organizations. The assessment program provides funding and technical assistance to help communities assess properties for the presence of hazardous substances. For more information about the BVCP or to apply for a site assessment, visit (<https://dnr.mo.gov/env/hwp/bvcp/hwpcvp.htm>.)

Ozark National Scenic Riverways

Question 43-46 on NEPA Form. Ozark National Scenic Riverways (ONSR), managed by the National Park Service (NPS), protects 134 miles of the Current and Jacks Fork Rivers in Shannon, Carter, Dent and Texas counties. The establishment of the Ozark National Scenic Riverways authorized the Secretary of the Department of the Interior to acquire interest, including scenic easements, on private land within the boundary of the Riverways. Scenic easements account for 9,257 acres within the ONSR, and are managed to maintain the natural environment and scenery for the benefit of the visiting public. Easements are designed to ensure that developments do not degrade the scenic and natural quality of private lands within the boundary of the Riverways. Scenic easements retain a 300 foot wide strip along the riverbanks that remains open to public use. If your project is within the scenic easement of the ONSR, contact FHWA and GMS immediately. Consultation between you, ONSR, FHWA and GMS staff is required before developing your project. On the NEPA Determination Form, describe the impacts your project will have and summarize the coordination with the NPS. List all environmental commitments required by the NPS.

Wild and Scenic Rivers

Question 47-50 on NEPA Form. The National Wild and Scenic Rivers System was created by Congress in 1968 to preserve certain rivers with outstanding natural, cultural and recreational values in a free-flowing condition for the enjoyment of present and future generations. A 44.4-mile section of the Eleven Point River in Oregon and Ripley counties is designated a Wild and Scenic River. About half the lands within the Eleven Point Scenic River are private lands, while the remainder of the area is managed by the U.S. Forest Service (USFS). The private lands along the Scenic River are protected by the USFS under scenic easements to ensure protection of their scenic values and natural resources. If your project is within the scenic easement of the Eleven Point River, contact FHWA and GMS immediately. Consultation between you, USFS, FHWA and GMS staff is required before developing your project. On the NEPA Determination Form, describe the impacts your project will have and summarize the coordination with the USFS. List all environmental commitments required by the USFS.

Farmlands

Question 51-54 on NEPA Form. In 1980, the Council on Environmental Quality directed that federal agencies must assess the effects of their actions on farmland soils classified by the Natural Resources Conservation Service (NRCS) as prime or unique. Because of this directive and the fact that your project will be receiving federal funding assistance, you will need to determine if the project will impact prime or unique farmland. Prime farmland is defined as soil that produces general crops such as common foods, forage, fiber, and oil seed. Unique farmland produces specialty crops such as fruits, vegetables, and nuts. To determine if your project site will be converting prime or unique farmland, use the NRCS' Web Soil Survey (<https://websoilsurvey.sc.egov.usda.gov/App/WebSoilSurvey.aspx>). The following screen shots outline the process for developing a soil survey of your project area.

If the soil survey indicates that your project will impact prime or unique farmland, you will need to complete parts I and III of the Farmland Conversion Impact Rating Form (<https://www.nrcs.usda.gov/conservation-basics/natural-resource-concerns/land/cropland/farmland-protection-policy-act>) and submit the form to your local NRCS field office (<https://www.nrcs.usda.gov/contact/find-a-service-center?state=29&county=> .) Coordinate completion of the form with the NRCS to determine if impacts generate a score of 160 or higher. Attach a copy of the soil survey and, if your project will be impacting prime or unique farmland, attach the completed Farmland Conversion Impact Rating Form to the NEPA Determination Form. If the impact rating score is 160 or higher, coordinate with GMS, FHWA and NRCS regarding what measures should be taken to minimize the impacts. List those measures in the commitment section on the NEPA Determination Form. If there are no impacts to prime or unique farmland or the score on the Farmland Impact Rating Form is less than 160, then no commitment statement is necessary.

Zoom in on Missouri using the magnifying glass. Next, draw a box around the project county.

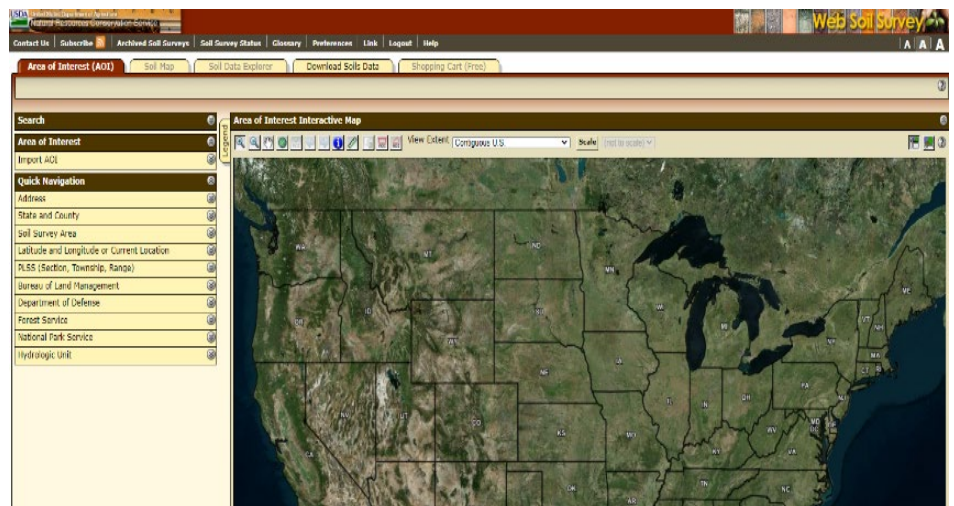

Use the AOI Polygon tool (circled) to indicate the project area. Remember to define the review area sufficiently large enough to account for any direct or indirect resource impacts and to accommodate for potential future modifications to the project footprint.

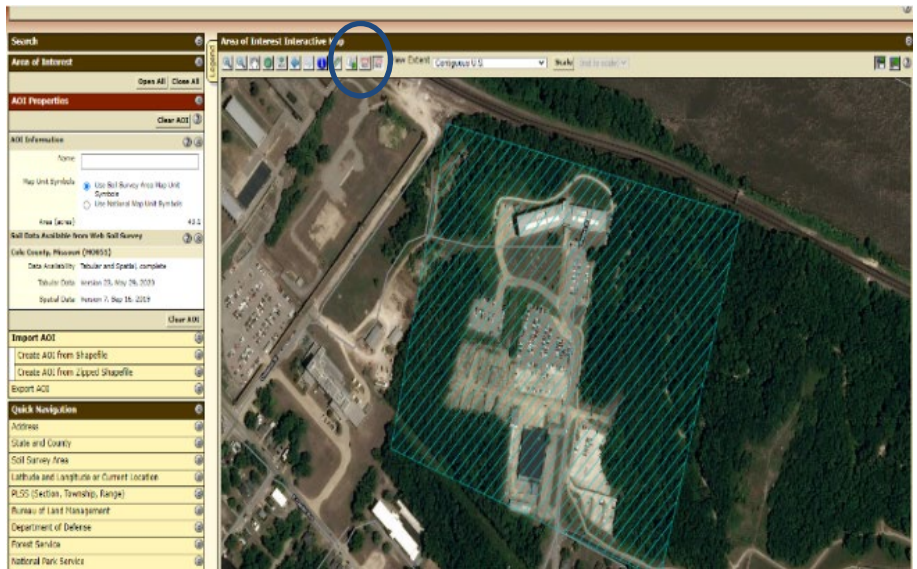

At the top, click on the "Soil Data Explorer" tab. Then expand the "Land Classification" and expand "Farmland Classification" and click "View Rating."

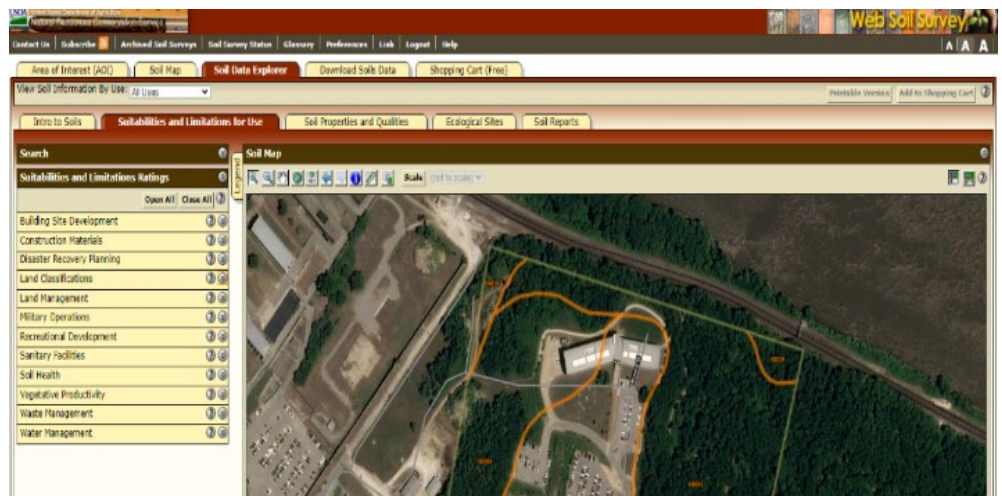



Warning: Soil Ratings Map may not be valid at this scale.
 You have zoomed in beyond the scale at which the soil map for this area is intended to be used. Mapping of soils is done at a particular scale. The soil surveys that comprise your AOI were mapped at 1:24,000. The design of map units and the level of detail shown in the resulting soil map are dependent on that map scale. Misalignment of maps beyond the scale of mapping can cause misunderstanding of the detail of mapping and accuracy of soil line placement. The maps do not show the small areas of contrasting soils that could have been shown at a more detailed scale.

Tables - Farmland Classification - Summary By Map Unit

Summary by Map Unit - Cole County, Missouri (MO051)

Map unit symbol	Map unit name	Rating	Acres in AOI	Percent of AOI
60004	Mentro silt loam, 14 to 20 percent slopes, eroded	Farmland of statewide importance	10.0	23.3%
60005	Mentro silt loam, 20 to 45 percent slopes	Not prime farmland	16.3	37.7%
60051	Urban land-Harvester complex, 3 to 15 percent slopes	Not prime farmland	1.4	3.2%
64010	Urban land-Freeburg complex, 0 to 3 percent slopes, rarely flooded	Not prime farmland	0.7	1.6%
66020	Hayme silt loam, 0 to 2 percent slopes, frequently flooded	Not prime farmland	0.6	1.3%
99027	Urban land, 3 to 15 percent slopes	Not prime farmland	14.2	32.8%
Totals for Area of Interest			43.1	100.0%

Description - Farmland Classification
 Farmland classification identifies map units as prime farmland, farmland of statewide importance, farmland of local importance, or unique farmland. It identifies the location and extent of the soils that are best suited to food, feed, fiber, forage, and oilseed crops. NRCS policy and procedures on prime and unique farmlands are published in the "Federal Register," Vol. 43, No. 21, January 31, 1978.

Rating Options - Farmland Classification
 Aggregation Method: No Aggregation Necessary
 Tie-break Rule: Lower

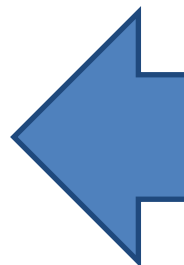

Scroll down to view the soil survey rating to determine if your project area will be impacting prime farmland. If the soil survey indicates existence of prime farmland, complete parts I and III of the Farmland Conversion Impact Rating Form. However, if the survey shows farmland and the area has been previously disturbed and is no longer farmland, on the NEPA form, mark "Yes" for question #52. In Question #53 explain that the area is no longer considered farmland due to A copy of the soil survey and Farmland Conversion forms should be included with the NEPA form.

Environmental Justice

Question 55-59 on NEPA Form. Presidential Executive Order 12898, "General Actions to Address Environmental Justice in Minority Populations and Low-Income Populations," requires all federal agencies to identify and address the disproportionately high or adverse human health or environmental effects of their programs and policies on minorities and low-income populations and communities. Because your project is receiving federal funding, you will need to determine if your project ensures environmental justice for all those who will be impacted by the project. According to the EPA, environmental justice is the fair treatment and meaningful involvement of all people, regardless of race, color, national origin, or income, with respect to the development, implementation, and enforcement of environmental laws, regulations, and policies. Fair treatment means that no group of people, including a racial, ethnic, or socioeconomic group, should bear a disproportionate share of the negative environmental consequences resulting from industrial, municipal, and commercial operations or the execution of federal, state, local, and tribal programs and policies.

Environmental justice pertains to minority populations and low-income populations. Low-income populations are those with household incomes at or below the Department of Health and Human Services poverty guidelines. Minority populations include the following five minority groups: Black, Hispanic or Latino, Asian American, American Indian and Alaskan Native, and Native Hawaiian or Other Pacific Islander. Use the EPA EJScreen search tool (<https://ejscreen.epa.gov/mapper/>) to determine if your project area contains populations that meet the low-income or minority population standards. Determine if your project area contains higher than average concentrations of these populations when compared to the rest of the community or county in which your project is located. If it doesn't, indicate so on the NEPA Determination Form. If your project area does contain a higher than average concentration of low-income or minority populations, determine if your project will disproportionately impact these populations. An example of a disproportionate impact would be if a low-income residential neighborhood flanks one side of a trail project and an affluent neighborhood flanks another and the trail project provides access to residents of the affluent neighborhood but doesn't provide access to residents from the low-income neighborhood. If the project does not disproportionately impact low-income or minority populations, indicate so on the NEPA Determination Form. If the project does disproportionately impact these populations, describe those impacts and what efforts will be done to minimize the impacts.

Also, you will need to conduct meaningful public outreach, including notice designed to reach all affected parties, including those with limited English proficiency. Describe any public outreach efforts that engaged the affected populations. Any commitments resulting from this should be stated in the space provided on the NEPA Determination Form.

Noise Impacts

Question 60-65 on NEPA Form. The Noise Control Act of 1972 established a national policy to promote an environment for the public free from noise that jeopardizes their health and welfare. For non-motorized trail projects, there are no noise requirements. An important consideration in the development of motorized projects is the impact of noise on other recreationists, nearby homes and nearby businesses. For motorized projects, the project sponsor must determine if construction of the trail will introduce a permanent noise source to a noise-sensitive area or move a noise source closer to a noise-sensitive area. The project sponsor must also engage in outreach efforts to determine if there are public concerns regarding noise impacts. If the project will introduce noise or move noise closer to a noise-sensitive area, or if there are concerns expressed by the public regarding negative impacts, a noise impact assessment must be conducted. Sponsors are strongly encouraged to hire or consult with a professional to conduct the assessment. On the NEPA Determination Form, describe the noise impacts of the project and list commitments that will be taken to minimize the impacts. These could include necessitating equipment requirements such as spark arrestors, mufflers or noise dissipative devices; implementing design features that absorb or decrease noise, such as using vegetation or terrain as natural sound barriers or constructing berms; and engaging in educational efforts, such as posting signs reminding users of trail etiquette.

Temporary Construction Impacts

Question 66-68 on NEPA Form. Another important aspect to consider is if project construction will temporarily impact recreational use or access to the project area during the construction period. You will need to determine if construction activities will cause any restrictions of access to the existing trail system or area (such as a park, any private properties, roadways, parking lots, playgrounds, pathways or sidewalks) where the project is being constructed. If it is a new trail where there is a significant impact to the use of the area, check yes and describe the impacts and what measures will be/have been taken to minimize those impacts. If it is a new trail and there are no significant impacts to the use of the surrounding area, then check no. If it is a renovation project, an alternative route should be signed and created (if needed) so users can continue to use the surrounding area. In this instance, check the yes box and describe the impacts (such as, duration of access restriction) and what measures will be taken to minimize those impacts (detours, signage, etc.). Additionally, describe how the public has been or will be informed of project construction (i.e., public hearings or meetings, informational letters or fliers mailed to adjacent property owners, temporary signage, etc.). Attach copies of minutes from any public hearings or meetings, copies of informational letters or fliers, screenshots of web or Facebook pages, etc., demonstrating efforts to inform the public about the construction activities.

Permanent Impacts to Travel Patterns

Question 69-71 on NEPA Form. Determine if the project will have a permanently negative affect on access to existing recreational facilities, private properties, parking facilities, roadways, pathways or sidewalks. If there will be any permanent negative access change as a result of the project, please describe those changes, what measures will be done to minimize impacts, and what outreach efforts you've initiated or will initiate to solicit public comment about the permanent impacts.

Public/Tribal Involvement

Question 72-74 on NEPA Form. Describe public outreach completed and/or planned for the project, including any efforts you may have implemented as part of or prior to the application process. Include copies of any documentation demonstrating proof of public outreach, such as newspaper advertisements for public meetings or hearings, meeting minutes, letters, fliers, questionnaires or online surveys, screenshots of web or Facebook pages, etc. Indicate if there is known public controversy or opposition to the project. Typically, opposition to a project does not occur until the construction begins, in which case having well-documented public involvement shows that the public was given an opportunity to comment. Describe what efforts you've taken to address or mitigate public concerns about the project.

Certification of Responsible Person

A responsible and duly authorized official of the sponsor's agency or organization must sign and date this section certifying that the information on the form is correct and that the project sponsor will adhere to the commitments outlined in the form. By signing, the project sponsor also acknowledges that any change in project scope or commitments will require further review and coordination with GMS and FHWA staff before implementing those changes.

Once you've completed the NEPA Determination Form, submit the form and all determination documentation to GMS at the address listed on the form. GMS staff will review the form and attached documentation. GMS staff will then submit the form and documents to FHWA for their review. FHWA staff will review the form and documentation and, if staff concurs that the project qualifies as a CE, will sign the form indicating concurrence and return the form to GMS. Upon receipt of FHWA's concurrence, a Notice to Proceed (NTP) letter will be sent to you authorizing you to begin final design. The NTP letter will reiterate the environmental commitments you must implement to avoid or minimize impact to resources and any other requirements needed for final design.

SECTION III. REAL PROPERTY ACQUISITION

Recreational Trails Program (RTP) legislation prohibits condemnation of any kind of interest in property; therefore, acquisition or lease of land or right-of-way easements on which to develop a trail project must be from a willing landowner. Additionally, acquisition of real property interests through easement or lease agreement must be for a period of at least 25 years. Provisions stated in the easement or lease agreement cannot be detrimental to the proposed recreational development. The easement or lease agreement must also state that it cannot be revoked at will by the landowner and that the land must be retained in public trail use for the duration of the easement or lease period. If the property is subject to any liens, further documentation may be required to demonstrate the requisite control of management to satisfy the 25-year requirement

All acquisition of real property with RTP funds must occur during phase II, whether through purchase, donation, easement or lease, and must comply with the Uniform Relocation Assistance and Real Property Acquisition Policies Act of 1970, as amended (http://www.ecfr.gov/cgi-bin/text-idx?tpl=/ecfrbrowse/Title49/49cfr24_main_02.tpl.) Known as the “Uniform Act,” this act also applies to acquiring property with non-federal funds when the intent is to apply for RTP funds for development of a trail project. In other words, a project sponsor cannot knowingly circumvent the federal law by acquiring real property with local funds and not follow the regulations of the act, and then apply for RTP funds at a later date to develop a trail or trailhead. The Uniform Act ensures that landowners are fully informed of their rights and are justly compensated when selling or leasing private property or selling/leasing any type of interest in the property (such as a trail easement or temporary construction easement). As part of this assurance, the Uniform Act requires an appraisal and an appraisal review to be performed. Additionally, the act also covers the provision of relocation assistance to owners or tenants displaced by the acquisition. Below are the steps you must perform to show compliance with the Uniform Act when acquiring real property with RTP funds. Appendix B provides the supporting documentation you will be required to submit to GMS to demonstrate compliance. You have up to six months to provide GMS staff the documentation showing compliance with the Uniform Act. **It’s important to remember that you are not authorized to take title to the property, even if it’s a donation, until GMS and FHWA staff have reviewed all compliance documentation, FHWA has authorized the project, and you’ve received a Notice to Proceed (NTP) letter from GMS.**

This section outlines specific procedures under the Uniform Act that you must follow when acquiring land with RTP funds. Appendix B provides a checklist of the documentation you are required to submit to GMS, as well as templates for the various letters and statements that are required. Once GMS has received your documentation, it will be submitted to FHWA for their review and approval. Upon receipt of concurrence from FHWA, GMS will issue you a NTP letter to acquire the real property or property interests.

- 1. Conduct title search.** Conduct a title search of the property to be acquired to determine ownership of the property, any liens or restrictions on the property, or any rights or interests held by others. It is recommended that a title company conduct the title search.
- 2. Contact seller.** Make initial contact with the seller to see if the land might be available for sale or for donation, if the landowner would be willing to negotiate a permanent easement or right-of-way, or if the landowner would be willing to lease the property for the trail project. At this point, the price cannot be negotiated since it must be based on an appraisal. If the initial contact is made via a telephone call, follow up with a letter that indicates notice of interest to the property. The Notice of Interest letter must include a statement of landowner rights, which is that a landowner has the right of just compensation for the property. Because condemnation is prohibited by RTP regulations, the letter must also state that the landowner’s property will not be condemned if the sponsor and landowner are unable to reach an agreement. A sample Notice of Interest letter is provided in Appendix B. Unless the project sponsor has their own written guidelines that fully incorporate compliance requirements of the Uniform Act and all applicable state and local requirements, sponsors are encouraged to enclose a copy of FHWA’s booklet entitled, “Acquisition: Acquiring Real Property for Federal and Federal-Aid Programs and Projects.” A pdf of the booklet can be found at (https://www.fhwa.dot.gov/real_estate/uniform_act/acquisition/acquisition.pdf.)
- 3. Determine relocation assistance eligibility.** Determine whether or not the owners, any business(es), or any tenants on the property might be eligible for relocation assistance. The landowner and any tenants must be informed of their relocation rights. It is recommended that both the owner and any tenants be given a copy of FHWA’s booklet entitled, “Relocation: Your Rights and Benefits as a Displaced Person under the Federal Relocation Assistance Program,” a PDF of which can be found at (https://www.fhwa.dot.gov/real_estate/publications/your_rights/rights2014.pdf). While not typical to most acquisition projects related to trail development, a relocation plan will be required for any persons displaced from the acquisition of the property. Refer to FHWA’s “Relocation” booklet for more information.
- 4. Conduct appraisal and appraisal review.** Before negotiating a purchase price with the landowner, the real property to be acquired must be appraised. Have the property appraised by a licensed appraiser, with the landowner given the opportunity to accompany the appraiser. The appraisal must then be reviewed by a certified review appraiser. Costs for both of these are eligible for reimbursement or can be used as part of the sponsor’s match as planning costs up to 10% of the grant request, if they were identified in the budget table and narrative. GMS does not provide appraisal services. For a list of certified

appraisers, visit (<https://pr.mo.gov/licensee-search-division.asp>.) A list of qualified appraisers and review appraisers maintained by the Missouri Department of Transportation may be found at the following link: <https://www.modot.org/sites/default/files/documents/Roster%2520of%2520Approved%2520Contract%2520Appraisers%5B1%5D.pdf>. The names on these lists are not an endorsement and you are not required to use someone from either list. Projects sponsors must verify all qualifications to make sure they are suitable for your project. Exceptions to the appraisal requirement include the following conditions:

- a. Waiver valuation when fair market value is less than \$10,000.** If the acquisition of property is not complicated and a review of the available data suggests that the fair market value will likely be \$10,000 or less, an appraisal is not required. Instead, a waiver valuation from a qualified person knowledgeable of the general market values in the project area will be acceptable. A sample Waiver Valuation has been provided in Appendix B. Note that the averaging of the final values of two or more appraisal reports to estimate the fair market value of a property is unacceptable and does not meet the requirements of the Uniform Act.
 - b. When property is being donated.** An appraisal is also not required when the landowner is donating the property and releases the project sponsor from their obligation to appraise the property. However, if the value of the donated property is being used as the project sponsor's match, an appraisal or waiver valuation will still need to be conducted to determine the fair market value of the property, in order to determine the match amount.
- 5. Establishment and Offer of Just Compensation.** Before initiating negotiations with the property owner, the project sponsor must establish an amount which they believe is just compensation for the real property. The amount can't be less than the approved appraisal of the fair market value of the property and must take into account the value of allowable damages or benefits to any remaining property. The project sponsor will then make a written offer to the owner to acquire the property for the full amount believed to be just compensation. The written offer must enclose a copy of the appraisal and appraisal review and must be either hand delivered or sent by certified or registered first-class mail, return receipt requested (documentation of the delivery date must be kept in the project file and a copy sent to the GMS for its records). Appendix B provides a sample Offer of Just Compensation.
- 6. Statement of Just Compensation.** The Offer of Just Compensation must also include a written statement for the basis of the Offer of Just Compensation. The statement must include the amount offered as just compensation; a description and location identification of the real property and/or the interest in the real property to be acquired; identification of the buildings, structures and other improvements which are included as part of the offer; and whether or not there are any other separately held ownerships in the property (such as tenant-owned improvements) – the statement must indicate that these ownership interests are not included in this offer. If the project sponsor is acquiring a portion of the property and not the whole, there may be damages or benefits to the remaining property. The Statement of Just Compensation must also reflect these damages or benefits. A sample Statement of Just Compensation is provided in Appendix B.
- 7. Real property donations.** In the case where the landowner is willing to donate the real property, an Offer of Just Compensation and a Statement of Just Compensation are not required. Instead, the landowner must sign a Waiver of Right to Just Compensation, which states that the landowner waives their rights to just compensation and agrees to donate the property or property interest. Appendix B provides a sample Waiver of Right to Just Compensation. In some cases, a landowner may be willing to sell real property for less than the full market value, but is not able to donate the entire value of the land. The difference between the sale price and the appraised fair market value can be considered donated land value. For a RTP project, federal reimbursement may be provided for the purchase part of the acquisition but not for the donated part. However, the donated value can be used as match for the purchase cost of the same tract of property or for development costs of the trail project. Landowners making partial donations must also sign a Waiver of Right to Just Compensation. By signing, the landowner is acknowledging a partial donation of the property and waives his or her rights to compensation for the donated parcel. The appraisal requirements outlined above apply to both full and partial donations, as do the requirements for notifying the landowner and any tenants of their rights.
- 8. Landowner negotiations.** Once the landowner has received the Offer of Just Compensation and Statement of Just Compensation, the owner must be given reasonable opportunity to consider the offer and present any additional information or material the owner believes is relevant to determining the value of the property. The owner must also be given an opportunity to suggest modifications to the proposed terms and conditions of the purchase.
- 9. Updating Offer of Just Compensation.** The project sponsor must have the initial appraisal updated or obtain a new appraisal if the information presented by the owner indicates the need is warranted; or if a material change in the character or condition of the property is such that it requires updated information; or if a significant delay has occurred since the initial appraisal. If the new appraisal information indicates that a change in the purchase offer is warranted, the sponsor must provide the landowner with a new Offer of Just Compensation and Statement of Just Compensation reflecting this updated appraisal information.
- 10. Provide justification for purchase offer if higher than appraised value.** The purchase price for the property may exceed the amount offered as just compensation when reasonable efforts to negotiate an agreement at that amount have failed and the

project sponsor considers the higher price as being reasonable, prudent and in the public interest. A detailed and well-documented statement on this difference with all pertinent appraisal documents and a history of negotiations documenting discussions of price between the landowner and the sponsor should be submitted. The statement should also indicate the importance of the proposed purchase as opposed to other alternative sites, or other justification regarding the need to purchase the subject property at a higher amount. If GMS and FHWA agree the higher negotiated price represents a reasonable cost, that amount can be eligible for assistance if sufficient funds are available in the fiscal year apportionment and have not already been obligated to other grant projects.

- 11. Notice to Proceed letter required before purchasing the property.** Once GMS and FHWA staff review all of the above required compliance documentation and concur with the findings, a Notice to Proceed (NTP) letter will be sent to the project sponsor. At this point, the sponsor will be able to move forward in acquiring the real property. **Do not acquire the property until receiving the NTP letter.**
- 12. Record the deed.** Once the sponsor has paid the negotiated purchase price, any closing costs, relocation benefits, etc., and taken title to the property, the deed must be recorded with the Recorders Officer and a copy submitted to GMS. Sponsors must hold the property as trustee for the public trust per 2 CFR 200.316 and include a deed clause indicating the land will remain a public trust for a minimum of 25 years (Notice of Limitation of Use), must not encumber the property and must include a statement regarding disposition instructions pursuant to 2 CFR 200.311. Also see 2 CFR 910.360 for additional requirements for real property and equipment relative to for-profit project sponsors. The deed must also include a non-discrimination statement as required by 49 C.F.R. § 21 <https://www.ecfr.gov/current/title-49/subtitle-A/part-21?toc=1>
- 13. Submit reimbursement request.** A reimbursement request for the RTP share of the acquisition costs should then be submitted to GMS, the process for which is outlined in Section V.

Please remember to follow these procedures when acquiring real property for the purposes of this project and obtain a notice to proceed. Failure to comply with this federal law may result in the termination of your project, as RTP funds cannot be used to construct on property that was not acquired in accordance with federal acquisition laws.

SECTION IV. PROJECT DEVELOPMENT

Maintaining Your RTP Project File

Before you begin developing your project, you'll need to create a project file that includes relevant documents. The file must be made available upon request for audit purposes and must be maintained for a period of five years starting from the date of submission of the final payment request (see "Record Retention" in Section VI of this manual). The project file will also help keep your project organized and on-track as you complete each stage of the project. The project file should include the following documents:

- **RTP application and supporting documentation.** A copy of your RTP grant request application and the supporting documentation you were required to submit with the application should be kept in your project file. GMS uses the project narrative, budget table and budget narrative from your application to develop the project scope and budget indicated on the Financial Assistance Agreement, so a copy of the application is a helpful reference document to have in your file.
- **Proof of land ownership or leaseholder/easement rights.** A copy of the land deed, lease or easement agreement is required if the project sponsor currently owns or leases the land for the project, or has a permanent trail easement. The lease or easement agreement must show a 25-year non-revocable commitment.
- **Financial Assistance Agreement.** A signed copy of the Financial Assistance Agreement must be kept in your project file. The Financial Assistance Agreement is between the project sponsor and the Department and includes the project number, used for identification purposes; the project title which should be used on all future correspondence regarding the project; the project period, including a start date and an end date; a description of the project scope; the total project budget; and the amount of RTP funds requested. Additionally, the agreement provides a signature line for Division of State Parks' Director and the project sponsor, also referred to as the subrecipient. Signature on the Financial Assistance Agreement is the subrecipient's acceptance of all federal laws, agency policies, and regulations and procedures applicable to federal financial assistance awards. The agreement requires the language of certifications and terms applicable to financial assistance awards to be included in subaward documents at all tiers and that the subrecipient shall certify and disclose accordingly pursuant to 2 CFR 200.331. All flow down requirements imposed on the subrecipient by the Department are to ensure the RTP award is used in accordance with federal statutes, regulations, and the terms and conditions of the RTP award. The subrecipient is accountable to the Department for compliance with federal requirements. In turn, the Department is responsible to the FHWA for ensuring that subrecipients comply with federal requirements and with RTP's general terms and conditions: (http://www.fhwa.dot.gov/environment/recreational_trails/guidance/.) See Appendix H for a sample agreement. All project sponsors must comply with the administrative requirements described at 2 CFR 200, as amended.
- **Subrecipient Information Form.** Retain a copy of the signed Subrecipient Information Form that you were given during the administration workshop. The Subrecipient Information Form is a requirement of the Federal Funding Accountability and Transparency Act (FFATA), which provides oversight and transparency for the expenditure of federal funds.
- **State of Missouri Vendor Input/ACH-EFT Application.** Keep a copy of the completed Vendor Input/ACH-EFT Application in your file, but remember to also submit the application to the Office of Administration. This process allows electronic reimbursement funds to be transferred to your agency's or organization's bank account.
- **NEPA Determination Form.** Your file should also include a copy of the NEPA Determination Form you were required to complete as part of the NEPA review, as well as the supporting documentation that you submitted. Additionally, your file should include copies of all agency determination letters and any other correspondence from those agencies regarding their review of your project. A final copy of the NEPA approval should be retained.
- **Real property acquisition documentation.** For land acquisition projects, the project file should retain a copy of each of the documents listed on the Real Property Acquisition Documentation Checklist in Appendix B.
- **Notice to Proceed.** Copies of the Notice to Proceed (NTP) letters from the Department must be retained in your file as well. The NTP letters will be sent to you if GMS and FHWA staff concur with all compliance documentation required by NEPA, the Uniform Act and Buy America. The NTP letters will outline any required environmental commitments that must be incorporated in the project. **You are not authorized to start any construction activities, acquire property, or materials before receiving a NTP letter.**

Documents that will be added to your project file as you move toward completing your project include the following, which must be retained for the retention period as well:

- Planning and engineering documents and specifications
- Bid documents and signed contracts
- Any required permits
- A completed accessibility checklist and a written policy regarding use of Other Power-Driven Mobility Devices (OPDMD)
- Proof of compliance with Buy America (if Federal Award amount is greater than \$500,000)
- All written correspondence between you and GMS, and you and any contractor, supplier, etc., working on your project

- Copies of project amendment requests, if required
- An as-built site map
- As-built facility plans if using RTP funds to construct trailhead or trailside amenities
- Reimbursement documentation, including copies of invoices, employee and volunteer timesheets, equipment use logs, etc. (see Section V of this guide for more detail)
- Completed quarterly report forms, as described in Section V
- Project close-out documentation, which is described in Section VI of this guide

Project Development Procedures

Project sponsors must comply with federal, state and local laws and regulations for entity type, type of project, and dollar amount of materials or services being purchased to perform the project. The following guidance highlights frequent terms affecting most contracts but is not an exhaustive list.

Development of a project site may be by contract, force account (in-house labor), in-kind contribution, or a combination of these methods. The procedures regarding each of these methods are explained below, as are the procurement procedures for purchasing services and materials. The project sponsor should use their own documented procurement procedures that reflect applicable state and local laws and regulations, provided that procurement conforms to the federal Brooks Act (<https://www.gpo.gov/fdsys/pkg/FR-2015-05-22/pdf/2015-12024.pdf>), standards set forth in the "Uniform Administrative Requirements, Cost Principles and Audit Requirements for Federal Awards" (<http://www.ecfr.gov/cgi-bin/text-idx?SID=e5a3e230b18df274b27ba83528b43156&mc=true&node=pt2.1.200&rgn=div5>); general procurement standards, including conflict of interest, may be found at 2 CFR 200.318 and methods to follow at 2 CFR 300.320, with varying requirements depending on the type of entity. Project sponsors must also comply with the terms and conditions outlined in the "Missouri Department of Natural Resources Federal Financial Assistance Agreements General Terms and Conditions." A copy of the Department's terms and conditions is found in Appendix D.

Contracting for Engineering and Design Related Services:

All procurement of engineering and design services shall conform to the Brooks Act and RSMo. Chapter 8 Section 291 and per the Department's terms and conditions outlined in Appendix D, every effort must be made to solicit bids from minority business enterprises (MBE) and women business enterprises (WBE). To find certified MBE and WBE firms, use the Missouri Office of Equal Opportunity's MBE/WBE search webpage (<https://apps1.mo.gov/MWBCertifiedFirms/>) and search by "Services Provided."

Project sponsors must inform all bidders that federal funds are being used in the project, and all relevant federal, state and local requirements apply. For the procurement of engineering and design services, the project sponsor shall formally advertise through its website and for a minimum of three weeks (one insertion per week for a total of three insertions over a 3 week period) in a local newspaper a written description of the proposed services request and evaluate responding firms as follows:

1. The project sponsor shall list three highly qualified firms and shall then select the firm considered best qualified and capable of performing the desired work and negotiate a contract for the project with the firm selected.
2. For a basis for negotiations the project sponsor shall prepare a written description of the scope of the proposed services.
3. If the project sponsor is unable to negotiate a satisfactory contract with the firm selected, negotiations with that firm shall be terminated. The project sponsor shall then undertake negotiations with another of the qualified firms selected. If there is a failing of accord with the second firm, negotiations with such firm shall be terminated. The project sponsor shall then undertake negotiations with the third qualified firm.
4. If the project sponsor is unable to negotiate a contract with any of the selected firms, the project sponsor shall reevaluate the necessary architectural, engineering or land surveying services, including the scope and reasonable fee requirements, again compile a list of qualified firms and proceed in accordance with the provisions of sections 8.285 to 8.291 RSMo.
5. The provisions of sections 8.285 to 8.291 RSMo. shall not apply to any political subdivision which adopts a qualification-based selection procedure commensurate with state policy for the procurement of architectural, engineering and land surveying services.

Project sponsors must submit proof of the procurement process prior to signing a contract with the firm for GMS approval. Documentation includes:

- proof of advertisement including the affidavit of publication
- list of top three contractors
- resume of selected contractor
- A justification statement of why they were deemed the most qualified

The final contract must include the following forms:

- **Certification Regarding Debarment, Suspension, and Other Responsibility Matters, Drug-Free Workplace Requirements and Lobbying:** found in Appendix E. To ensure that ineligible contractors are not awarded a contract, project sponsors are required to check the Contractor Debarment List maintained by the Missouri Department of Labor and Industrial Relations, at (<https://labor.mo.gov/contractor-debarment-list>.) Project sponsors are also required to check with the U.S. Department of Labor's Office of Federal Contract Compliance Programs for a list of contractors that have been declared ineligible to receive federal contracts (<https://www.dol.gov/ofccp/regs/compliance/preaward/debarlst.htm>.)
- **Business Entity Certification, Enrollment Documentation, and Affidavit of Work Authorization:** Found in Appendix E. All contractors must affirm their enrollment and participation in a federal work authorization program with respect to employees working in connection with the project. Every such business entity shall also sign an affidavit affirming that it does not knowingly employ any person who is an unauthorized alien in connection with the project. Documentation shall include 1) EITHER the E-Verify Employment Eligibility Verification page listing the company name and company ID OR a page from the E-Verify Memorandum of Understanding (MOU) listing the company name and the MOU signature page completed and signed, at minimum, by the company and the Department of Homeland Security – Verification Division. If the signature page of the MOU lists the company's name and company ID, then no additional pages of the MOU must be submitted; AND 2) submit a completed, notarized Affidavit of Work Authorization. Should you need assistance in obtaining documentation you can contact the E-Verify federal work authorization program (Website: (http://www.dhs.gov/files/programs/gc_1185221678150.shtm;) Phone: 888-464-4218; Email: (E-Verify@uscis.dhs.gov.)

Once GMS has received your procurement packet request, a notice to proceed will be issued that allows the project sponsor to contract with the firm. The project sponsor will have 15 days from the date that the contract was signed to send GMS a copy of the final contract including the compliance forms listed above. Any changes made to the contract after it has been signed must be submitted to GMS for approval on the change order form included in this guide.

Purchase/Service Contracts Under \$25,000:

After receipt of the appropriate NTP letter(s), no other approval is required from GMS staff for purchase or service contracts under \$25,000. We ask that you make every effort to solicit a fair number of bids or estimates to ensure the most advantageous and cost-efficient contract is made for your project. You are not required to provide documentation of this procurement to GMS. However, you are required to maintain a record of it in your file for auditing purposes.

Contracting for Purchase/Service Contracts \$25,000 or Greater:

Per the Department's terms and conditions outlined in Appendix D, every effort must be made to solicit bids from minority business enterprises (MBE) and women business enterprises (WBE). To find certified MBE and WBE firms, use the Missouri Office of Equal Opportunity's MBE/WBE search webpage (<https://apps1.mo.gov/MWBCertifiedFirms/>) and search by "Services Provided." Project sponsors must inform all bidders that federal funds are being used in the project, and all relevant federal, state and local requirements apply. You must also inform all bidders, that this is an equal opportunity bidding event and MBE/WBE firms are encouraged to respond.

Bids must be solicited through a formally-advertised, sealed-bid process. A copy of all bidding documents must be submitted to GMS for approval prior to advertising for bids. Construction plans must include a project map that labels areas and resources that need to be avoided during construction, as identified during the NEPA review. Similarly, construction specifications must include all environmental commitments indicated on the NEPA Determination Form. GMS staff will make every effort to review and approve your bid documents within two weeks of receiving. Note that GMS review of bids and contracts does not relieve you of the responsibility for full compliance with federal, state and local regulations applicable to your project. The project sponsor shall formally advertise through its website and for a minimum of three weeks (one insertion per week for a total of three insertions over a 3 week period) in a local newspaper a written description of the proposed services request and evaluate responding firms. An Affidavit of Publication should be provided with the bidding documents for proof of publication.

Contracts must be awarded to the lowest responsible and responsive contractors or suppliers who have the ability to perform successfully under the terms and conditions of the contract. Prior approval must be obtained from GMS before awarding the contract. When the project sponsor considers the lowest bidder unresponsive or not responsible, the next lowest bidder may be awarded the contract. If a contract is awarded to other than the lowest bidder, a letter of justification for this action must be sent to GMS with the bid summary. Copies of the bid tabulation summary sheet and all contracts must be submitted to GMS within 15 (fifteen) days after awarding the contract. Any proposed change orders to the contract must first be cleared with GMS and approved by FHWA before the change order is negotiated using the change order form in this guide.

*Pursuant to 2 CFR 200.317, project sponsors who are state agencies must follow the same policies and procedures they use for procurements from non-federal funds, but also must incorporate the contract compliance provisions for federal RTP funds required in this manual.

The following documentation must be included in the bidding documents:

- **Form FHWA-1273 must be physically included in all Federal-Aid construction contracts** and is found in Appendix C. A PDF copy can also be downloaded from (<https://mostateparks.com/page/61220/recreational-trails-program-rtp-grants>.) While Form FHWA-1273 may be referenced in bid proposal or request for proposal documents, the document itself must also be physically incorporated in all bidding documents and contains your promise to comply with certain laws, including laws relating to Disadvantaged Business Enterprises (DBE); failure to do so is considered a material breach and may result in termination of the contract. If an architectural or engineering firm prepares the plan specifications for the project, make sure their standard contractual statements do not conflict with federal requirements.
- **Affidavit of Compliance with Prevailing Wage Law.** If Missouri state prevailing wage law applies, it must be complied with for all projects considered “public works” pursuant to 290.230 RSMo; 8 CSR 30-310. At the completion of the construction work, the contractor must sign an affidavit indicating compliance with the act. The affidavit is found in Appendix E. Contract Compliance Required Documentation and can also be downloaded as a PDF copy from (<https://mostateparks.com/page/61220/recreational-trails-program-rtp-grants>.) 23 U.S.C. 113 states that the provisions of the Davis Bacon Act apply to all projects that are located within the right-of-way of a Federal-aid highway. A Federal-aid highway is defined as a highway on the Federal-aid highway system (the National Highway System and interstates). This excludes roadways functionally classified as local roads or rural minor collectors, which are exempt. Where applicable law requires that projects be treated as a project on a Federal-aid highway, the provisions of this subpart will apply regardless of the location of the project (excluding recreational trails projects).
- **Certification of Non-Segregated Facilities**, found in Appendix E.
- **Certification Regarding Debarment, Suspension, and Other Responsibility Matters, Drug-Free Workplace Requirements and Lobbying:** found in Appendix E. To ensure that ineligible contractors are not awarded a contract, project sponsors are required to check the Contractor Debarment List maintained by the Missouri Department of Labor and Industrial Relations, at (<https://labor.mo.gov/contractor-debarment-list>.) Project sponsors are also required to check with the U.S. Department of Labor’s Office of Federal Contract Compliance Programs for a list of contractors that have been declared ineligible to receive federal contracts (<https://www.dol.gov/ofccp/regs/compliance/preaward/debarlst.htm>.)
- **Business Entity Certification, Enrollment Documentation, and Affidavit of Work Authorization:** found in Appendix E. All contractors must affirm their enrollment and participation in a federal work authorization program with respect to employees working in connection with the project. Every such business entity shall also sign an affidavit affirming that it does not knowingly employ any person who is an unauthorized alien in connection with the project. Documentation shall include 1) EITHER the E-Verify Employment Eligibility Verification page listing the company name and company ID OR a page from the E-Verify Memorandum of Understanding (MOU) listing the company name and the MOU signature page completed and signed, at minimum, by the company and the Department of Homeland Security – Verification Division. If the signature page of the MOU lists the company’s name and company ID, then no additional pages of the MOU must be submitted; AND 2) submit a completed, notarized Affidavit of Work Authorization (sample included on page 10-13). Should you need assistance in obtaining documentation you can contact the E-Verify federal work authorization program (Website: (http://www.dhs.gov/files/programs/gc_1185221678150.shtm); Phone: 888-464-4218; Email: (E-Verify@uscis.dhs.gov).

Projects with a Federal Award \$500,000 or less: USDOT issued a public interest waiver for Buy America requirements effective 8/16/23 for specific projects of \$500,000 or less, subject to the following limitations. The waiver is from Buy America (BABA) requirements for De Minimis Costs and Small Grants to prepare for full compliance with the BIL’s new Made in America standards for construction materials. The public interest waiver of BABA’s domestic preferences is for projects funded under DOT-administered financial assistance programs, including the Recreational Trails Program administered in Missouri by the Missouri Department of Natural Resources, for iron, steel, manufactured products, and construction materials under a single financial assistance award for which the total amount of Federal financial assistance applied to the project, through awards or subawards, is below \$500,000. The waiver is applicable only to awards that are obligated, or subawards that are made, on or after the effective date of the waiver, 8/16/23.

Projects with a Federal Award Greater than \$500,000:

Buy America Provisions. Buy America provisions are to be included in all bid documents. The Bipartisan Infrastructure Law (BIL) established new Buy America requirements known as the Build America, Buy America Act (BABA). The Act requires the following Buy America preference:

- (1) All iron and steel used in the project are produced in the United States. This means all manufacturing processes, from the initial melting stage through the application of coatings, occurred in the United States.

(2) All manufactured products used in the project are produced in the United States. This means the manufactured product was manufactured in the United States, and the cost of the components of the manufactured product that are mined, produced, or manufactured in the United States is greater than 55 percent of the total cost of all components of the manufactured product, unless another standard for determining the minimum amount of domestic content of the manufactured product has been established under applicable law or regulation.

(3) All construction materials are manufactured in the United States. This means that all manufacturing processes for the construction material occurred in the United States. Pending OMB's issuance of final standards on construction materials, and absent any existing applicable standard in law or regulation that meets or exceeds these preliminary standards, agencies should consider "all manufacturing processes" for construction materials to include at least the final manufacturing process and the immediately preceding manufacturing stage for the construction material.

BIL allows FHWA to preserve existing Buy America policies and provisions that meet or exceed the standards required by the Act, such as its requirements for iron/steel and manufactured products under 23 U.S.C. 313 and 23 C.F.R. 635.410.

- Domestic manufacturing processes for any steel/iron products (including protective coatings) that are permanently incorporated in any project funded under Title 23 (Federal-Aid highway program) must meet the requirement with certifications on all steel/iron products and their coatings under 23 CFR 635.410(b)(1)(ii).
- An alternate bidding procedure may be used on projects with approval from FHWA Division Administrator (you must consult with the GMS office and follow the procedure agreed to by FHWA under C.F.R. 635.410(b)(3)).
- A minimal usage criteria for non-domestic products, which allows their usage if the cost of materials does not exceed one-tenth of one percent (0.1 %) of total project cost or \$2,500, whichever is greater under 23 CFR 635.410(b)(4) (documentation will be required prior to enacting the minimum usage criteria; consult with GMS staff).
- Existing manufactured products waiver in place since 1983 covers the manufactured product requirement above.

The BABA extends the application of Buy America to "Construction materials" which includes an article, material, or supply that is or consists primarily of:

- non-ferrous metals;
- plastic and polymer-based products (including polyvinylchloride, composite building materials, and polymers used in fiber optic cables);
- glass (including optic glass);
- lumber; or
- drywall.

Items excluded from "Construction materials" include cement and cementitious materials; aggregates such as stone, sand, or gravel; or aggregate binding agents or additives. Asphalt concrete pavement mixes are typically composed of asphalt cement (a binding agent) and aggregates such as stone, sand, and gravel. Accordingly, asphalt is also excluded from the term construction materials.

An article, material, or supply should only be classified into one of the following categories: (1) iron or steel; (2) a manufactured product; or (3) a construction material. For ease of administration, an article, material, or supply should not be considered to fall into multiple categories. Agencies should apply the iron and steel test to items that are predominantly iron or steel unless another standard applies under law or regulation.

Since the Recreational Trails Program is funded with Title 23 funds, project sponsors who use RTP funds to purchase any of the following must ensure that these items are manufactured in the United States: any iron/steel product and construction materials permanently incorporated into the project (such as bridges that use steel I-beams, fencing, rebar, posts, bolts, PCC, lumber, drywall, etc.). Additionally, any coating material applied to the iron/steel products must be applied in the United States. **All advertisements for bids and all contracts must include a Buy America provision.** FHWA requires step certifications for iron/steel, where each handler (supplier, fabricator, manufacturer, processor, applier of coatings, etc.) certifies that their step in the process was domestically performed. The contractor or vendor must provide these certifications prior to incorporation of the material in the project. See Appendix F for the step certification forms.

Force Account Labor and Use of In-House Equipment:

Salaries of in-house staff are eligible for the project sponsor's match if they conform with 23 CFR 635 Subpart B. Use of an agency's or organization's internal labor force should be valued at the current hourly rate of individual employees working on the project, and should be directly tied to completing the elements listed in the project scope. For use of in-house equipment, use the Federal Emergency Management Agency's (FEMA) Schedule of Equipment Rates to determine the cost of operating various pieces of mechanized equipment (<https://www.fema.gov/schedule-equipment-rates>). Documenting the use of force account labor and use of in-house equipment is discussed in Section V. Reimbursement and Reporting Requirements.

Donations:

The value of volunteer labor can also be used for the project sponsor's match. A volunteer's donated time will be valued at the current minimum wage rate per hour unless the person is professionally skilled in the work being performed on the project. When this is the case, the wage rate this individual is normally paid for performing this service may be used. For assistance in determining the wage rates by occupation in your area, visit the U.S. Department of Labor's Bureau of Labor Statistics website at (<https://www.bls.gov/bls/blswage.htm>.) For donated materials, use the fair market value of those items. Documenting the use of volunteer labor and donated material as match is discussed in Section V as well.

Signs

Projects that incorporate signs that function as traffic control devices must conform to the Manual on Uniform Traffic Control Devices (MUTCD), which can be found at (http://mutcd.fhwa.dot.gov/kno_2009r1r2.htm.) Signs that do not function as traffic control devices are not subject to the MUTCD. However, informational signs and kiosks must take into consideration the needs of various users, such as people who are blind or have impaired vision, people who use wheelchairs or other personal assistance mobility devices, and children. Refer to the Accessibility Checklist in Appendix G. Steel signs and signposts must also conform to Buy America requirements.

Invasive Species

Other factors to consider when developing your project include landscaping with native species and implementing measures to prevent the spread of noxious or invasive species. Project sponsors should landscape with native species for seeding and make sure all equipment brought on site is cleaned and inspected prior to use to ensure there is no plant debris or seeds from noxious weeds being spread by the equipment. For information about controlling noxious weeds, see the Missouri Department of Agriculture's website at (https://www.aphis.usda.gov/aphis/ourfocus/planthealth/plant-pest-and-disease-programs/pests-and-diseases/SA_Weeds/SA_Noxious_Weeds_Program.) For water trail projects that incorporate boat ramps or other access, it is recommended that information be provided to trail users on methods for preventing the spread of zebra mussels, a harmful exotic species that spreads rapidly by "hitchhiking" on boats. Information can be provided either through signage at trailheads or through print publication. The Missouri Department of Conservation has provided a factsheet that can be downloaded and printed (<https://mdc.mo.gov/fishing/protect-missouri-fishing/zebra-mussels>.)

Permitting

Several of the permits you will be required to acquire for completion of your project have already been outlined in Section II. NEPA Review and Determination. To ensure that your project follows all permitting requirements, it is recommended you visit the Department's ePermitting website (<http://dnr.mo.gov/env/wpp/epermit/help.htm>.) Additionally, you are expected to be familiar with and comply with any local permitting requirements that apply to your project.

Accessibility

As you begin designing your trail project, you must take into consideration the access needs of people with varying physical abilities. Failure to plan for and develop the project in accordance with accessibility requirements may result in the need for additional work before the final reimbursement can be released, and if corrective action is not feasible may require repayment of previously disbursed funds.

Federal regulations regarding accessibility and outdoor recreation are promulgated under two separate statutes, the Americans with Disabilities Act (ADA) and the Architectural Barriers Act (ABA). The ADA is a broad federal civil rights law that prohibits discrimination based on disability. The law defines "disability" as "...a physical or mental impairment that substantially limits a major life activity." The ADA has five main sections, or "titles," of which the relevant ones for this administration guide are Title II, which covers services and programs of state and local governments; and Title III, which covers "public accommodations." (Federal entities are covered by the ABA, which ensures that all federal facilities are fully accessible to everyone.)

Title II entities are non-federal public entities such as school districts, townships, cities, counties and states. Most RTP project sponsors fall under this category, such as a municipal park and recreation department. Title II reads in part, "No qualified individual with a disability shall, by reason of such disability, be excluded from participation in or be denied the benefits of services, programs, or activities of a public entity..." For more information about ADA as it relates to Title II entities, the U.S. Department of Justice (DOJ) has provided several online manuals that help explain what state and local governments must do to ensure that their

services, programs, and activities are provided to the public in a nondiscriminatory manner (<https://www.ada.gov/ta-pubs-pg2.htm>.)

Title III entities are private entities that provide public accommodations. Title III states that, “...no individual may be discriminated against on the basis of disability with regards to the full and equal enjoyment of the...facilities...of any place of public accommodation by any person who owns, leases (or leases to), or operates a place of public accommodation.” A place of public accommodation means a facility operated by a private entity whose operations affect commerce and fall within particular categories, including most places of recreation, transportation, education, dining, commerce, and lodging. For example, trails open to the public, which a nonprofit land trust manages on private land via trail easements, would constitute a place of public accommodation. The Department of Justice has provided several online manuals for Title III entities as well (<https://www.ada.gov/ta-pubs-pg2.htm>.)

Trailhead Amenities:

To provide guidance on how Title II and Title III entities should comply with the ADA, the Department of Justice has issued the 2010 ADA Standards for Accessible Design (https://www.ada.gov/2010ADASTandards_index.htm). These design standards are minimum accessibility standards for buildings and other structures. As of March 15, 2012, compliance with these regulations is required for any new construction and any alterations to existing facilities. The 2010 ADA Design Standards contain technical specifications for building and site elements common to trailheads, such as parking, accessible routes, ramps, drinking fountains, and restrooms. It also specifies how many accessibility features must be incorporated in each facility. Title II and Title III entities are required to provide accessible parking and accessible routes to connect users to any accessible recreation-related facilities that are subject to the 2010 ADA Design Standards.

For projects that use RTP funding for the development of trailhead amenities, such as restrooms, parking areas, access routes, etc., these facilities must be ADA-compliant. For your convenience, an accessibility checklist has been provided in Appendix G that provides the ADA design standards for the most common trailhead-related amenities, such as parking, access routes, restroom facilities, water fountains and hydrants, overlooks, etc. The accessibility checklist is also available at (<https://mostateparks.com/page/61220/recreational-trails-program-rtp-grants>.) Project sponsors are encouraged, however, to consult with a design professional for further assistance to ensure ADA compliance. At the completion of your project, you will be required to submit the checklist along with as-built facility plans and an as-built site map, in addition to other closeout documents, to GMS staff. If you will be incorporating features or elements not listed on the accessibility checklist, consult a design professional or the DOJ’s ADA standards manual to determine if accessibility standards are available.

Trails/Trailside Amenities:

It may not be practicable to implement accessibility standards for your trail development project (as opposed to a trailhead development project). There are several conditions or exceptions that may preclude making a trail accessible. For instance, a trail’s intended user group may make it impossible to design and construct a trail that is considered accessible – a mountain bike trail is a good example of this. Other conditions include the following:

- When existing terrain would make it impractical to design an ADA-compliant trail, such as a trail that is steeply sloped and would require extensive cuts or fill that would be difficult to construct and maintain, or would be difficult to prevent erosion and other drainage issues from occurring.
- When prevailing construction practices would prohibit the ability to construct an ADA-compliant trail. For instance, an area may only allow the use of hand tools for trail construction because of resource concerns or policy prohibitions (such as in a state-designated wild area), which would make the construction of an accessible trail virtually impossible.
- When constructing an accessible trail would fundamentally alter the setting or purpose of the area. For example, primitive trails in natural settings with little to no development or trails intended to provide a rugged experience would not be capable of being made accessible.
- When federal, state or local laws would prevent the construction activities required to make a trail accessible, because of impacts to a resource protected under the Endangered Species, National Historic Preservation, Wilderness, or National Environmental Policy acts or other federal, state or local laws protecting significant resources.

In addition, trail accessibility standards have not yet been developed and incorporated into the ADA for Title II and III entities, so the Department of Justice does not currently require local governments and private organizations to make their trails accessible. However, for the Recreational Trails Program, project sponsors are strongly encouraged to incorporate accessibility standards where feasible. To this end, GMS staff recommends project sponsors use the U.S. Access Board’s accessibility standards manual entitled, “Outdoor Developed Areas: A Summary of Accessibility Standards for Federal Outdoor Developed Areas,” which includes trail standards for pedestrian trails (<https://www.access-board.gov/guidelines-and-standards/recreation-facilities/outdoor-developed-areas/a-summary-of-accessibility-standards-for-federal-outdoor-developed-areas>.) Although this manual was developed for federal facilities, it has applicability to other agencies and organizations attempting to develop accessible and sustainable outdoor recreation areas. Additionally, the U.S. Forest Service (USFS) has

compiled a comprehensive manual that incorporates accessible design standards for outdoor settings and trails that uses the Access Board's standards manual, but provides a more detailed explanation of each standard's technical requirements with illustrative graphics (<https://www.fs.usda.gov/sites/default/files/FSTAG-2013-Update.pdf> .) Both of these manuals only cover trails intended for pedestrian use and do not cover trails for other types of use, such as bicycling, equestrian, water or ATV trails.

For accessibility guidance in developing trails for other than pedestrian use, the following resources may be helpful:

- *Equestrian Design Guidebook for Trails, Trailheads, and Campgrounds* (http://www.fhwa.dot.gov/environment/recreational_trails/publications/fs_publications/07232816/index.cfm)
- *Pennsylvania Trail Design & Development Principles: Guidelines for Sustainable Non-Motorized Trails* (http://www.dcnr.state.pa.us/cs/groups/public/documents/document/dcnr_20028130.pdf)
 - American Trails' Resource Library for Accessible Trails (<https://www.americantrails.org/resource-library>)
 - American Trails' Resource Library for Motorized Trail Recreation <https://www.americantrails.org/tags/ohv>
- The Federal Highway Administration's resource webpage for manuals and guides on trail design, construction, maintenance, operation and signs (http://www.fhwa.dot.gov/environment/recreational_trails/guidance/manuals.cfm)
- *Pennsylvania Trail Design Manual For Off-Highway Recreational Vehicles* (http://www.dcnr.state.pa.us/cs/groups/public/documents/document/dcnr_002295.pdf)
- For water trails that include launch ramps, see the Access Board's guide on boating facilities (<https://www.access-board.gov/webinars/2022/08/04/accessible-recreational-boating-facilities-and-fishing-piers-and-platforms/> .)
- The Iowa Department of Natural Resources has put together a guide for designing water trails, available as a free pdf download. Chapter 3 of the guide addresses universal design in water trails (<http://www.iowadnr.gov/Things-to-Do/Canoeing-Kayaking/Water-Trail-Development> .)
- For assistance with providing information about trails to trail users with disabilities, visit Access Recreation's website at (http://www.accessrecreation.org/home/Access_Recreation_Home.html .)
- FHWA has compiled a list of resources related to trail design, construction and maintenance at (http://www.fhwa.dot.gov/environment/recreational_trails/publications/ .)

For your convenience, the most common pedestrian trail accessibility standards from both the Access Board and Forest Service manuals have been added to Section 4 in the accessibility checklist in Appendix G. If you indicated on your project application that you intended to make your trail project (as opposed to a trailhead project) meet ADA guidelines, then you will need to complete the accessibility checklist and submit it along with an as-built map of your project to GMS when closing out your project.

Other Power-Driven Mobility Devices (OPDMD):

In March 2011, the Department of Justice issued regulations regarding ADA and the use of Other Power-Driven Mobility Devices (OPDMD) on trails open to the public. These regulations cover trails managed by Title II and Title III entities. The regulations distinguish between wheelchairs and OPDMDs. A wheelchair is a device purposely designed for use by a person with a mobility-impairment. An OPDMD, on the other hand, is a device not expressly designed for, but can be used by, a person with a mobility-impairment. OPDMDs are any devices or vehicles powered by batteries, fuel or other engines, that can be used by a person with a mobility-impairment for the purpose of locomotion. This includes golf carts, Segways®, ATVs, ORVs, etc., without regard to size, width, weight or horsepower.

A person who has a mobility impairment may use an OPDMD on public trails UNLESS a prior assessment of that route or area has determined the use of the specific class of OPDMD the person has requested to use cannot be operated in that location:

- without creating a substantial risk of serious harm to the immediate environment, or natural or cultural resources; or,
- because it poses a safety risk to users; or,
- because it poses a conflict with federal land management laws and regulations.

The assessment must demonstrate a thorough review of the following five assessment factors:

- the type, size, weight, dimensions and speed of the class of device;
- the facility's volume of pedestrian traffic;
- the facility's design and operational characteristics;
- whether legitimate safety requirements can be established to permit the safe operation of that specific class of OPDMD at that facility;
- and, as outlined above, whether the use of the OPDMD creates a substantial risk of serious harm to the immediate environment or natural or cultural resources, or poses a conflict with federal land management laws and regulations.

If, after completing an assessment, a trail manager determines that there are trails that cannot accommodate the use of certain types of OPDMDs (or any at all) because of the risk factors described above, the managing entity will then need to draft a written policy that establishes adequate reasons for banning or limiting OPDMD use based on the above five assessment factors. The public will also need to be informed, in advance, of the OPDMD policy. These requirements relate in general to existing trails open to public use but, more specifically, they also relate to new trail projects. This means that, in order to comply with the OPDMD regulations, project sponsors using RTP funds for trail projects will need to complete an assessment of the new trail to determine if it can accommodate OPDMDs and, if their use must be restricted, draft an OPDMD policy and demonstrate that the public has been informed of the policy. There are no specific rules for informing the public, so posting the policy to the project sponsor's website or Facebook page, or posting information at the trailhead, is considered sufficient demonstration. A screenshot of the website or Facebook page, a photo of the information posted at the trailhead, or some other proof that the public has been informed will need to be submitted to GMS staff, along with a copy of the assessment and the OPDMD policy, when you submit your project closeout documentation.

American Trails has provided a very comprehensive webpage that addresses questions regarding the interpretation of the OPDMD regulations (<https://www.americantrails.org/resources/basic-facts-on-department-of-justice-rule-on-power-driven-mobility-devices-for-accessibility>). They have also compiled a list of state, local and private organizations that have completed assessments and drafted OPDMD policies, and have provided links to those policies at (<https://www.americantrails.org/resources/analysis-of-policies-addressing-trail-accessibility-rule-on-power-driven-mobility-devices>). These resources may be helpful to you when completing your trail assessment and drafting an OPDMD policy (where necessary) but it's important that you don't just adopt another organization's OPDMD policy without evaluating and documenting the five assessment factors outlined above. A written policy alone, without a supporting assessment, will not meet the Department of Justice's requirements. To read the DOJ ruling related to state and local governments (28 CFR § 35.137), see (https://www.ada.gov/regs2010/titleII_2010/titleII_2010_withbold.htm.) To read the DOJ ruling related to private organizations that provide public access (28 CFR § 36.311), see (https://www.ada.gov/regs2010/titleIII_2010/titleIII_2010_withbold.htm.)

SECTION V. REIMBURSEMENT AND REPORTING REQUIREMENTS

This section describes the process for submitting quarterly status reports; funding reimbursement requests, including required cost documentation and time accounting records; and requesting project amendments, such as changes in project scope or time extensions.

Quarterly Reports

After you've received your NTP letter(s) and have begun developing your project, you will be expected to keep GMS apprised of the status of your project through quarterly reports. The reports need to be submitted each quarter until the project is complete. The Quarterly Report Form can be found in Appendix H. The form has also been provided as a fillable PDF that can be downloaded from (<https://mostateparks.com/page/61220/recreational-trails-program-rtp-grants>.) The quarters are as follows: January-March, April-June, July-September and October-December of each calendar year. You should submit your quarterly report by the end of the month following each quarter; see the below table. Reports should be emailed to the contact information provided on page 4 of this guide. It is recommended that you establish some form of reminder system to alert you when the reports are due. GMS staff may send you a friendly reminder if your quarterly report hasn't been submitted. Reimbursements may not be processed if quarterly reports are not submitted as required.

Quarterly Reports Schedule	
Quarter	Due Date
January – March	April 30
April – June	July 31
July – September	October 31
October – December	January 31

Amendment Requests

In unusual circumstances, you may find that you need to amend an element of your financial assistance agreement. Amendments to your financial assistance agreement will require FHWA approval to ensure your project's eligibility. A significant change in project scope may also require additional NEPA evaluation. The process for requesting amendments is outlined below.

Time Extensions:

Should you be unable to complete your project by the end date of your project period because of extenuating or unusual circumstances beyond your control, you may request a time extension using the Extension Request in Appendix H. An electronic request form is also available upon request from GMS staff. Time extension requests MUST be made six months before your original project period expires to ensure funding remains available for your project. When reviewing your request, GMS staff may require additional information from you such as a revised schedule for completing key milestones and an assurance that the project is still viable. The form should be emailed to the contact information provided on page 4 of this guide.

Change in Project Scope:

Proposed changes to the project scope must be made in writing to GMS staff by email. GMS will in turn coordinate with FHWA staff for their approval to ensure that the project eligibility remains valid. Include an explanation for why you cannot complete the project as originally approved as well as a justification of the proposed change. Approved project scopes may change the amount of grant reimbursement you receive. You must also provide documentation that the change in project scope does not conflict with the project scope described in the NEPA documentation. If the change is outside of what was cleared in the NEPA document or impacts resources previously not impacted, then a reevaluation is needed and any appropriate coordination with resource agencies needs to be completed.

Change in Project Budget:

Often when your project scope changes, so will your project budget table. You can move up to 10% of your grant award between budget categories without GMS approval. Moving more than 10% of your grant award between budget categories requires GMS and FHWA approval. If you wish to move more than 10% of the grant funds in your budget, submit a request in writing to the GMS office. Include the proposed new budget breakdown. A project sponsor can request a budget amendment increase in an amount not-to-exceed 25% of the original project agreement amount and only when the increase costs are associated with the project components approved in the original project scope. To request a budget amendment, send a letter or email to the GMS that includes the total cost of the requested change along with the reasoning for the request. Adding new budget categories would likely constitute a change in project scope and would require GMS and FHWA approval. If this is the case, a NEPA reevaluation may also be required and documentation provided before any approval could be granted.

Project Cancellation

In extreme circumstances, you may determine that your organization will be unable to complete your project and will need to cancel the project. Your project must be withdrawn prior to any reimbursement of grant funds and prior to signing any contracts. Once a partial reimbursement has been made, the project cannot be withdrawn. To withdraw a project, submit a written request to GMS.

Reimbursement Requests

Grantees are encouraged to submit reimbursements as they are invoiced for project costs. For each Phase of the project that has funds allocated, a reimbursement must be submitted before moving onto the next Phase. In order to ensure that the project does not become inactive, project sponsors are required to submit at least one reimbursement request every six months.

Reimbursement requests should be emailed to the contact information on page 4 of this guide. Reimbursement requests must include the following:

- **Reimbursement Statement**, provided in Appendix H and also online at (<https://mostateparks.com/page/61220/recreational-trails-program-rtp-grants>.) The Reimbursement Statement is the signed statement from the project sponsor formally requesting grant reimbursement. For each Reimbursement Statement submitted, indicate whether this is the first billing, second billing, or third and so on, under “Billing Number” at the top of the form. The total cost for your project this billing period must agree with the total of all invoices, labor, equipment, in-kind contributions and donations shown on the Reimbursement Log form.
- **Reimbursement Log**, provided in Appendix H and also online at (<https://mostateparks.com/page/61220/recreational-trails-program-rtp-grants>.) The Reimbursement Log documents the costs of your project and should reflect the list of eligible costs indicated in your budget table. Each item listed on the log must be supported by the appropriate documentation, as outlined in the Cost Documentation section below.
- **Individual and Volunteer Time Record**, provided in Appendix H and online at the address above. Use the Time Record to document the hourly rate of all force account (in-house) employees and all volunteers working on the project. See the Cost Documentation section below for further details.
- **Equipment Use Log**, also provided in Appendix H and online at the address above. The Equipment Use Log documents the cost of in-house equipment usage and, when appropriate, the cost of using loaned equipment, as outlined in the Cost Documentation section below.

Cost Documentation

Only eligible costs will be reimbursed or allowed to be used as the sponsor’s match. Eligible costs are those that relate directly to your project scope, are specified in your project budget table and narrative, and were incurred within the project period identified on your financial assistance agreement. Pre-award planning, engineering and environmental review costs may be used as a portion of the project sponsor’s match, as long as those costs do not exceed 10% of the total project cost and were incurred within 18 months prior to construction authorization. All costs incurred by the sponsor for both contract work and work performed by the sponsor personnel for whom reimbursement is sought must be supported by original source documents or documentation which provided adequate assurance that the quantities of completed work were determined accurately and on a uniform basis.

Documentation of Contract Labor:

When submitting invoices to the project sponsor for completed work, in addition to documentation, which may be required to demonstrate compliance with federal prevailing wage law, contractors on projects subject to state prevailing wage laws must also include a certified copy of their employee payroll and a signed Statement of Compliance indicating that the payrolls are correct and complete and that each employee has been paid the prevailing wage rate for the work performed in accordance with Missouri’s Prevailing Wage Law. For more information about Missouri’s prevailing wage requirements, rates, and how to complete the Contractors Payroll Form (https://labor.mo.gov/pubs-and-forms?search=contractors+payroll+&division=All&doctype=All&topic=All&items_per_page=10), visit the Missouri Department of Labor and Industrial Relations prevailing wage webpage at (<http://labor.mo.gov/DLS/PrevailingWage/pwContractors>.)

Documentation of Force Account Labor and In-House Equipment Usage:

This type of cost involves the use of your organization’s paid work crews (on your payroll) and/or equipment in the completion of your project. Use the Individual and Volunteer Time Record for each employee who works on an aspect of the project. Indicate the employee’s hourly rate at the top of the form. The description of work must be tied directly to the project’s scope. Both the employee and their supervisor must sign the Individual and Volunteer Time Record. Copies of payroll checks must accompany the time record forms and reflect the dates indicated on the forms. Additionally, a copy of the employee’s earnings record, which shows rate of pay, gross pay and deductions for the pay period, must be included. A computer payroll register may be substituted for the earnings record. Fringe benefit reports must indicate the percentage each fringe benefit is of gross salary.

Track equipment use on the Equipment Use Log, using one form for each type of equipment used and noting the type of equipment, hours of use, and hourly rate. The Equipment Use Log must be signed by the equipment operator and his/her supervisor. Use the Federal Emergency Management Agency's (FEMA) Schedule of Equipment Rates to determine the cost of operating various pieces of mechanized equipment (<https://www.fema.gov/schedule-equipment-rates>).

Documentation of Volunteer Services:

The value of volunteer labor can also be used for the project sponsor's match. A volunteer's donated time will be valued at the current minimum wage rate per hour unless the person is professionally skilled in the work being performed on the project. When this is the case, the wage rate this individual is normally paid for performing this service may be used. For assistance in determining the wage rates by occupation in your area, visit the U.S. Department of Labor's Bureau of Labor Statistics website at (<https://www.bls.gov/bls/blswage.htm>.) Use the Individual and Volunteer Time Record for each volunteer who works on an aspect of the project. The description of work must be tied directly to the project's scope. Both the volunteer and the project manager must sign the Individual and Volunteer Time Record.

The value of donated supplies, materials and equipment that are permanently acquired should be reasonable and not exceed the current market prices at the time they are purchased for the project. Use the Reimbursement Log to record donated contributions of supplies and materials, and provide the fair market value by listing the comparable prices from other vendors or the amount paid by the donor. Cash donations must be documented by a copy of the check from the donor and a copy of the project sponsor's bank account statement showing the deposit. If your project includes the value of a land donation, the steps you followed in Section III will have provided you with an appraisal valuation, a copy of which you will have already submitted to GMS. Document the appraised value of the real property on the Reimbursement Log.

Occasionally, equipment used in the construction of a facility will be loaned to the project sponsor. The sponsor may claim the value of the equipment use as donated contribution to the sponsor's share of project costs. Use the Equipment Use Log as you would for in-kind equipment usage and, in place of the employee signature, have the volunteer sign instead. The project manager supervisor must sign as well. Use FEMA's Schedule of Equipment Rates to evaluate the cost of operating the piece of equipment.

Documentation of Purchase:

Follow the Contracting and Buy America requirements outlined in Section IV., as applicable. Use the Reimbursement Log to record any materials, supplies. Submit supporting documentation with the log, which includes copies of invoices, copies of receipts, and copies of proof of payment (such as cancelled checks). Ensure all copies of invoices and receipts are legible. Invoices should include the project number assigned to your project, as indicated on your financial assistance agreement. Invoices must be dated prior to the project period end date and paid for within 30 days after the project end date. Ensure that any checks written to pay invoices and receipts are from the project sponsor's bank account.

Final Reimbursement Request

Your final reimbursement request should be submitted within **60 days** after project completion or following the end date of the project period indicated on your financial assistance agreement, whichever comes first. The final reimbursement request should include the Reimbursement Statement, the Reimbursement Log, the Individual and Volunteer Time Record form, the Equipment Use Log as appropriate, and all supporting cost documentation as outlined above. Additionally, a Final Inspection Request and a Project Closeout Packet must accompany your final reimbursement request. A copy of the Final Reimbursement Request is provided in Appendix I and detailed instructions for completing it and compiling the Project Closeout Packet are included in Section VI. Project Closeout and Post-Completion Requirements.

SECTION VI. PROJECT CLOSEOUT, POST-COMPLETION REQUIREMENTS, AND REMEDIES FOR NONCOMPLIANCE

Project Completion

The date of completion is the date when all work in a project is completed, or the date the project expires, whichever comes first. The project sponsor should submit the final reimbursement request, final inspection request and all required project close-out documents within **60 days** after the date of completion (see the Project Closeout Packet section below). GMS staff will conduct a final inspection of the project site, using the as-built plans submitted by the project sponsor, the original project scope, and any subsequent amendments as aids in determining project compliance, including compliance with accessibility standards.

RTP Acknowledgement Sign

Once the project is complete, a sign acknowledging the Recreational Trails Program must be posted at the project site, and should be placed at the entrance to a trailhead or trail. An acknowledgement sign must be maintained at the project site for at least 25 years. For your convenience, a RTP sign will be provided by the GMS at the time of the final inspection or ribbon cutting.

Project Closeout Packet

Documents to be submitted as part of your project closeout packet include the following. Use the Project Closeout Documents Checklist in Appendix I to ensure that you have submitted all required documentation. GMS staff must receive your project closeout packet within 60 days after the date of completion, to ensure time to schedule an inspection, resolve any outstanding issues and process your final reimbursement request.



- **Final reimbursement request.** Use the Reimbursement Statement form provided in Appendix H (or the electronic form at (<https://mostateparks.com/page/61220/recreational-trails-program-rtp-grants>)). Under “Billing Status,” check the box marked “Final.” Include a Reimbursement Log, relevant time and equipment use records, and all pertinent cost documentation, as outlined in Section V.
- **Final Inspection Request form.** A copy of the Final Inspection Request form is provided in Appendix I. On the form, provide three potential dates when you or someone from your organization who is familiar with the project could meet with GMS staff for a final inspection. It’s important that the proposed dates fall within a 30-day window following the submittal of your project closeout packet. This will give GMS time to contact you to schedule an inspection and you time to resolve any outstanding issues noted by GMS during the inspection. Additionally, it will allow GMS time to process your final reimbursement.
- **As-built site map.** An as-built site map must be submitted showing the location of the project area and any trailhead/trailside facilities. The plan must identify the work funded by the grant, completion date, and boundaries of the site. The plan must also identify any accessible amenities and structures, and should include a copy of the completed Accessibility Checklist. In a few cases, there may be no changes from the site map submitted with the application other than labeling it with the completion date. This plan will become a part of the permanent records maintained by GMS on behalf of the Department. It is also to be kept permanently in the project sponsor’s public property records and available for public inspection with the financial assistance agreement.
- **As-built facility plans.** As-built plans showing elevations and floor plans of all structures and facilities must be submitted. The plans must also indicate the accessibility standards that were incorporated into the project. A copy of the completed Accessibility Checklist must also be included.
- **Post-Construction Certification.** A copy of the signed Post Construction Certificate (found in the Appendix I) must accompany the final reimbursement for development projects. This form is to be completed by the supervising architect or engineer on the project. If the project did not involve a contract architect or engineer, then the project sponsor’s architect, engineer or project manager should inspect the project and sign the Post Construction Certification.
- **Control and tenure documentation.** If not already submitted to GMS, copies of property titles, leases, easements, or appropriate documents must be submitted as part of a project’s documentation. This includes copies of deeds or easements of real property acquired with RTP funds or real property donated as part of this project. It also includes the mandatory easement for recording the 25 year stewardship requirements (found in Appendix I).

Record Retention

For audit purposes, the project sponsor will need to retain financial records, supporting documents, environmental clearances and all other records pertinent to the RTP grant for a period of five years starting from the date of submission of the final payment request, per Section B of Appendix D (Missouri Department of Natural Resources Federal Financial Assistance Agreements General Terms and Conditions). Stewardship documents must be maintained for as long as they are required by the Department in accordance with the terms and conditions of this grant. Refer to Section IV for a list of documents you are required to maintain in your project file.

Long-Term Stewardship Responsibilities

Property developed with federal assistance must be properly operated and maintained for general public use. The site should appear attractive and inviting to the public. Proper sanitation and sanitary facilities should be maintained in accordance with applicable federal, state and local standards. The site should be kept safe for public use. Buildings, roads, and other improvements should be kept in reasonable repair throughout their lifetime to prevent undue deterioration and to encourage public use. Evidence of vandalism should be repaired as quickly as possible.

Inspections:

Completed projects will be inspected periodically by GMS staff. Copies of the inspection reports will be sent to the project sponsor. The purpose of these inspections is to ensure that the site is being used for the purposes intended; the site is attractive and properly maintained; and the area is accessible and open to the general public.

Public access:

All facilities developed with RTP funds must be operated and maintained in public use for 25 years. The facility should be kept open for general public use at reasonable hours and times of the year according to the type of area or facility. The project must be open to entry and use by all persons regardless of race, religion, color, sex, national origin, age, disability, or place of residence. The site cannot be restricted for use only by community or county residents. Project sponsors may impose reasonable limits on the type and extent of use of areas and facilities developed with RTP funds when such a limitation is necessary for maintenance or preservation.

If fees are charged to use federally-funded sites or facilities, the project sponsor must submit a complete schedule of all charges to be assessed for those using the facilities to GMS. If trails are partially funded by local tax revenues, a higher user fee may be charged to out-of-city or out-of-county residents. Where there is no charge for residents, but a fee is charged to nonresidents, nonresident fees cannot exceed fees charged for residents at comparable state or local public facilities. Reservations, membership or annual permit systems available to residents must also be available to nonresidents and the period of availability must be the same for both.

Maintenance requirements for equipment purchased with RTP funds:

The use, control and maintenance of equipment purchased with RTP funds must follow the procedures outlined in Section H in Appendix D (Missouri Department of Natural Resources Federal Financial Assistance General Terms and Conditions). It is especially incumbent on you to ensure that any equipment purchased with RTP funding will be used primarily for the construction and maintenance of the trail-related projects. You are required to establish adequate safeguards to prevent against loss, damage, or theft of the equipment, and to develop adequate maintenance procedures to keep the equipment in good condition for its useful life.

Remedies for Noncompliance:

Failure to comply may result in termination of the subaward or subcontract, or such other remedy as the Department deems appropriate, which may include, but is not limited to, action to withhold further payments, disallow all or part of the cost of the activity, disqualify the subrecipient or subrecipient's contractor from future bidding as non-responsible, or repayment of previously disbursed amounts. If there is a breach of the minimum 25-year stewardship requirement, the remedy may require sale of the property pursuant to a disposition instrument consistent with 2 CFR 200.311 and proceeds used to repay the award.



GENERAL PROJECT INFORMATION

1. PROJECT NUMBER PROJECT TITLE

2. NAME OF PROJECT SPONSOR

ADDRESS

CITY STATE ZIP

3. PROJECT CONTACT PERSON

EMAIL ADDRESS PHONE FAX

4. LOCATION OF PROJECT: COUNTY IN WHICH THE PROJECT IS LOCATED CITY OR TOWN IN WHICH THE PROJECT IS LOCATED (If project is not located within city limits, indicate nearest city or town.)

TOWNSHIP, RANGE, SECTION LATITUDE LONGITUDE

5. IS PROJECT LOCATED ON STATE OR FEDERAL LAND? NO YES

IF YES, INDICATE NAME OF AREA AND NAME OF AGENCY

6. PROJECT IS EXEMPT FROM NEPA REVIEW BECAUSE IT: (Indicate which of the following conditions apply and skip to Certification of Responsible Person.)
 IS AN EDUCATIONAL PROJECT THAT DOES NOT INCLUDE CONSTRUCTION ACTIVITIES IS FOR EQUIPMENT PURCHASE ONLY

7. PROVIDE A DESCRIPTION OF THE PROJECT SCOPE AND FOOTPRINT OF THE ENVIRONMENTAL REVIEW AREA (Attach map delineating both the project limits and the environmental review area.)

SECTION 106 REVIEW

8. WERE ANY HISTORIC PROPERTIES IDENTIFIED WITHIN THE PROJECT AREA?
 YES (Complete Question 9) NO (Skip to Question 12)

9. PROVIDE A DESCRIPTION OF IDENTIFIED HISTORIC PROPERTIES

10. INDICATE THE EFFECT DETERMINATION INDICATED IN THE CULTURAL RESOURCE ASSESSMENT FROM SHPO (Attach a copy of the SHPO determination letter.)
 NO HISTORIC PROPERTIES AFFECTED NO ADVERSE EFFECT ADVERSE EFFECT (Must have an executed MOA attached)



11. LIST ANY MITIGATION/COMMITMENTS REQUIRED BY SHPO

12. BY MARKING THE BOX BELOW, YOU ARE AGREEING TO COMPLY WITH THE FOLLOWING ENVIRONMENTAL COMMITMENT:

- If the current project area or scope of work are changed or a borrow area is included in the project, work must stop and appropriate information must be provided to SHPO for further review and comment. If potential historic, cultural, archaeological, or paleontological resources are encountered during construction activities, work shall cease immediately and SHPO and GMS will be contacted for further consultation. No work can resume until Section 106 Review is satisfactorily completed.

THREATENED AND ENDANGERED SPECIES

13. PLEASE ADDRESS THE IMPACTS THE PROJECT WILL HAVE ON THE LISTED THREATENED AND ENDANGERED SPECIES, INCLUDING INFORMATION ABOUT THE SPECIES' HABITATS AND ENVIRONMENT.



14. LIST MITIGATION COMMITMENTS THAT WILL BE FOLLOWED OR INCORPORATED TO AVOID OR MINIMIZE THE IMPACTS TO THE SPECIES LISTED ABOVE
(If more space is needed, attach separate sheets.)

SECTION 6(F)(3) LANDS

15. IS THE PROJECT LOCATED WITHIN A PARK OR OTHER LAND PROTECTED UNDER 6(F)(3) OF THE LAND AND WATER CONSERVATION FUND?
(Attach a copy of the determination letter from GMS staff)

YES (Complete Question 16) NO (Skip to Question 18)

16. DESCRIBE IMPACTS OF PROJECT ON 6(F)(3) LAND

17. LIST ANY COMMITMENTS REQUIRED BY GMS TO AVOID OR MINIMIZE ADVERSE EFFECTS TO 6(F)(3) LAND



IMPACT TO JURISDICTIONAL WATERS

18. WILL JURISDICTIONAL WATERS AND/OR WETLANDS BE IMPACTED BY THIS PROJECT?

- YES (Complete Question 19) NO (Skip to Question 22)

19. DESCRIBE THE EXTENT OF THE IMPACT TO JURISDICTIONAL WATERS AND/OR WETLANDS

20. INDICATE THE TYPE OF PERMIT ANTICIPATED 404 NWP 404 INDIVIDUAL PERMIT 401 CONDITIONAL PERMIT 401 INDIVIDUAL PERMIT

21. LIST ANY COMMITMENTS REQUIRED BY THE USACE AND DNR TO AVOID IMPACTS TO THE RESOURCES. INCLUDE COMMITMENT STATEMENT TO ABIDE BY CONDITIONS REQUIRED BY USACE AND DNR (Attach a copy of the USACE determination letter and a copy of the DNR determination letter, as appropriate.)

WATER QUALITY

22. WILL YOUR PROJECT DISTURB AN ACRE OR MORE OF GROUND?

- YES (Complete Question 23) NO (Skip to Question 28)

23. ARE THERE ANY SENSITIVE AREAS WITHIN THE ENVIRONMENTAL REVIEW AREA, SUCH AS WELLS, SINKHOLES, STREAMS, SPRINGS OR CAVES?

- YES (Complete Question 24) NO (Skip to Question 27)

24. ARE ANY PROJECT IMPACTS ANTICIPATED FOR THESE AREAS?

- YES (Complete Question 25) NO (Skip to Question 26)

25. DESCRIBE IMPACTS OF PROJECT ON SENSITIVE AREAS



MISSOURI DEPARTMENT OF NATURAL RESOURCES
DIVISION OF STATE PARKS
FEDERAL RECREATIONAL TRAILS PROGRAM CFDA 20.219
NEPA DETERMINATION FORM (PAGE 5 of 13)

26. IF NO IMPACTS ARE ANTICIPATED, PLEASE INDICATE REASON(S) FOR THIS CONCLUSION

27. LIST CONDITIONS REQUIRED BY THE LAND DISTURBANCE PERMIT, INCLUDE COMMITMENT STATEMENT TO ABIDE BY THE CONDITIONS REQUIRED BY THE PERMIT (Attach a copy of the Land Disturbance Permit)

FLOODPLAIN IMPACTS

28. IS YOUR PROJECT WITHIN A FLOODPLAIN OR SPECIAL FLOOD HAZARD AREA?
 YES (Complete Question 29) NO (Skip to Question 32)

29. DESCRIBE IMPACTS OF PROJECT ON FLOODPLAIN OR SPECIAL FLOOD HAZARD AREA

30. INDICATE THE NAME OF THE PERMIT REQUIRED AND THE NAME OF THE ISSUING COMMUNITY OR COUNTY (Attach a copy of the permit.)

31. LIST CONDITIONS REQUIRED BY THE PERMIT, INCLUDE COMMITMENT STATEMENT TO ABIDE BY THE CONDITIONS REQUIRED BY THE PERMIT



AIR QUALITY

32. IS YOUR PROJECT LOCATED WITHIN THE ST. LOUIS OR KANSAS CITY METROPOLITAN PLANNING ORGANIZATION AREAS?

- YES (Complete Question 33) NO (Skip to Question 35)

33. DOES THE MPO CONSIDER YOUR PROJECT "REGIONALLY SIGNIFICANT?" (Attach a copy of any correspondence from the MPO.)

- YES (Complete Question 34) NO (Skip to Question 35)

34. INDICATE THE PROCESS OUTLINED BY THE MPO FOR INCLUSION OF YOUR PROJECT IN THE TIP

35. WILL YOUR PROJECT REQUIRE OPEN BURNING OF VEGETATIVE WASTE FROM LAND CLEARING?

- YES (Complete Question 36) NO (Skip to Question 38)

36. INDICATE THE NAME OF THE PERMIT REQUIRED AND THE NAME OF THE ISSUING AGENCY (Attach a copy of the permit)

37. LIST CONDITIONS REQUIRED BY THE PERMIT, INCLUDE COMMITMENT STATEMENT TO ABIDE BY THE CONDITIONS REQUIRED BY THE PERMIT

HAZARDOUS WASTE

38. ARE THERE ANY KNOWN HAZARDOUS WASTE SITES WITHIN THE ENVIRONMENTAL REVIEW AREA?

- YES (Complete Question 39) NO (Skip to Question 42)

39. ARE ANY PROJECT IMPACTS ANTICIPATED FOR THESE SITES? NO YES



40. DESCRIBE IMPACTS OF PROJECT ON HAZARDOUS WASTE SITES, OR JUSTIFY WHY NO IMPACTS ARE ANTICIPATED

41. LIST COMMITMENTS THAT WILL BE INCORPORATED TO AVOID HAZARDOUS SITES IN THE PROJECT AREA

42. BY MARKING THE BOX BELOW, YOU ARE AGREEING TO COMPLY WITH THE FOLLOWING ENVIRONMENTAL COMMITMENT:

If potential hazardous materials are encountered during construction, work shall cease at that location until a hazardous materials expert has reviewed the location and completed any necessary coordination and remediation. In the event hazardous materials are encountered, DNR shall be contacted immediately.

OZARK NATIONAL SCENIC RIVERWAYS

43. IS THE PROJECT WITHIN THE OZARK NATIONAL SCENIC RIVERWAYS SCENIC EASEMENT?

YES (Complete Question 44) NO (Skip to Question 47)

44. DESCRIBE IMPACTS OF PROJECT ON THE SCENIC EASEMENT

45. SUMMARIZE COORDINATION EFFORTS WITH NPS



46. LIST ANY COMMITMENTS REQUIRED BY NPS TO AVOID OR MINIMIZE ADVERSE IMPACTS

WILD AND SCENIC RIVERS

47. IS THE PROJECT WITHIN THE ELEVEN POINT SCENIC RIVER SCENIC EASEMENT?

YES (Complete Question 48)

NO (Skip to Question 51)

48. DESCRIBE IMPACTS OF PROJECT ON THE SCENIC EASEMENT

49. SUMMARIZE COORDINATION EFFORTS WITH USFS

50. LIST ANY COMMITMENTS REQUIRED BY USFS TO AVOID OR MINIMIZE ADVERSE IMPACTS

FARMLANDS

51. DOES YOUR PROJECT IMPACT PRIME OR UNIQUE FARMLAND?

YES (Complete Question 52)

NO (Skip to Question 55)



52. DESCRIBE IMPACTS OF PROJECT ON PRIME OR UNIQUE FARMLAND

53. PER THE FARMLAND CONVERSION IMPACT RATING FORM, IS THE IMPACT SCORE 160 OR HIGHER? (Attach a copy of the Farmland Conversion Impact Rating Form)

YES (Complete Question 54) NO (Skip to Question 55)

54. LIST COMMITMENTS REQUIRED BY THE NRCS, GMS AND FHWA TO MINIMIZE IMPACTS (Attach a copy of any correspondence from the NRCS, GMS AND/OR FHWA)

ENVIRONMENTAL JUSTICE

55. DOES YOUR PROJECT AREA CONTAIN HIGHER THAN AVERAGE CONCENTRATIONS OF LOW-INCOME OR MINORITY POPULATIONS WHEN COMPARED TO THE REST OF THE COMMUNITY OR COUNTY IN WHICH YOUR PROJECT IS LOCATED?

YES NO

56. DESCRIBE HOW YOU WERE ABLE TO MAKE THE ABOVE DETERMINATION

57. WILL YOUR PROJECT DISPROPORTIONALLY IMPACT LOW-INCOME OR MINORITY POPULATIONS IN THE PROJECT AREA?

YES (Complete Question 58) NO (Skip to Question 59)

58. DESCRIBE IMPACTS AND WHAT EFFORTS WILL BE DONE TO MINIMIZE THE IMPACTS AND INCLUDE COMMITMENTS RESULTING FROM PUBLIC OUTREACH EFFORTS



**FEDERAL RECREATIONAL TRAILS PROGRAM CFDA 20.219
NEPA DETERMINATION FORM (PAGE 10 of 13)**

59. IF YOU INDICATED YOUR PROJECT WILL NOT DISPROPORTIONALLY IMPACT LOW-INCOME OR MINORITY POPULATIONS IN THE PROJECT AREA, DESCRIBE HOW YOU WERE ABLE TO MAKE THAT DETERMINATION

NOISE

60. IS THIS A MOTORIZED PROJECT?

YES (Complete Question 61)

NO (Skip to Question 66)

61. ARE ANY SENSITIVE AREAS NEAR THE PROPOSED PROJECT?

YES (Complete Question 62)

NO (Skip to Question 63)

62. WILL THE PROJECT BE MOVING A NOISE SOURCE CLOSER TO OR INTRODUCING A NOISE SOURCE TO SENSITIVE AREAS?

YES

NO

63. DESCRIBE WHAT ACTIONS HAVE BEEN PERFORMED TO SOLICIT PUBLIC COMMENT ABOUT NOISE IMPACTS (Attach copies of any public outreach efforts.)

64. DESCRIBE ANY CONCERNS EXPRESSED BY THE PUBLIC REGARDING NOISE IMPACTS

65. DESCRIBE NOISE IMPACTS AND WHAT EFFORTS WILL BE DONE TO MINIMIZE THE IMPACTS (Attach a copy of the noise impact assessment, if required.)



TEMPORARY CONSTRUCTION IMPACTS

66. WILL TEMPORARY CONSTRUCTION ACTIVITIES SIGNIFICANTLY IMPACT USE OF OR ACCESS TO THE PROJECT AREA?

- YES (Complete Question 67) NO (Skip to Question 69)

67. DESCRIBE CONSTRUCTION IMPACTS AND WHAT EFFORTS WILL BE DONE TO MINIMIZE THE IMPACTS

68. DESCRIBE HOW THE PUBLIC HAS BEEN OR WILL BE INFORMED OF THE CONSTRUCTION ACTIVITIES (Attach copies of any public outreach efforts.)

PERMANENT IMPACTS TO TRAVEL PATTERNS

69. WILL THE PROJECT RESULT IN ANY PERMANENTLY NEGATIVE IMPACTS AFFECTING TRAVEL PATTERNS?

- YES (Complete Question 70) NO (Skip to Question 72)

70. DESCRIBE PERMANENT NEGATIVE IMPACTS AND WHAT EFFORTS WILL BE DONE TO MINIMIZE THE IMPACTS

71. DESCRIBE WHAT ACTIONS HAVE BEEN OR WILL BE PERFORMED TO SOLICIT PUBLIC COMMENT ABOUT THE PERMANENT IMPACTS (Attach copies of any public outreach efforts.)



PUBLIC/TRIBAL INVOLVEMENT

72. DESCRIBE ALL PUBLIC OUTREACH COMPLETED OR PLANNED FOR THIS PROJECT (Attach copies of any public outreach efforts.)

73. IS THERE ANY KNOWN CONTROVERSY OR OPPOSITION TO THE PROJECT?

YES (Complete Question 74) NO (Skip to Certification of Responsible Person)

74. DESCRIBE EFFORTS TO ADDRESS OR MITIGATE PUBLIC CONCERNS ABOUT THE PROJECT

CERTIFICATION OF RESPONSIBLE PERSON

A RESPONSIBLE OFFICIAL FROM THE SPONSORING ORGANIZATION MUST SIGN AND DATE THE NEPA DETERMINATION FORM.

"By signing below, I hereby certify that the information contained in this NEPA Determination Form is true and correct to the best of my knowledge. I understand that any changes in scope, limits, impacts or commitments after the signing of this document require coordination with the Missouri Department of Natural Resources and Federal Highway Administration staff. I further agree to implement the commitments outlined in this form and in the Notice to Proceed letter(s) submitted by the Missouri Department of Natural Resources."

SIGNATURE		TITLE
PRINTED NAME		DATE

EMAIL COMPLETED APPLICATION

Submit an original signed copy of this form and all required determination documentation to the Grants Management Section at the following email address msspgrants@dnr.mo.gov. Retain a copy of this form for your files.



GRANTS MANAGEMENT SECTION USE ONLY

T&E EFFECT DETERMINATION:

- NO EFFECT
 - MAY AFFECT, NOT LIKELY TO ADVERSELY AFFECT (USFWS concurrence attached.)
 - MAY AFFECT, LIKELY TO ADVERSELY AFFECT (USFWS concurrence and Biological Assessment attached.)
- SUMMARY OF COMMITMENTS REQUIRED BY USFWS ATTACHED

COMMENTS

The Missouri Department of Natural Resources, Division of State Parks, Grants Management Section has reviewed the information provided in this form and the attached determination documentation and has determined that the proposed action is categorically excluded from the requirement to prepare an Environmental Assessment or Environmental Impact Statement under the National Environmental Policy Act.

SIGNATURE

TITLE

PRINTED NAME

DATE

FEDERAL HIGHWAY ADMINISTRATION USE ONLY

NEPA CLASS OF ACTION:

- CE: Based on the information provided by the project sponsor in this form, the recommendation for approval from the Grants Management Section on behalf of the Missouri Department of Natural Resources, and in accordance with 23 CFR 771.117, this action is categorically excluded. No significant impacts will occur.
- EA: Based on the information provided by the project sponsor in this form and in accordance with 23 CFR 771, an Environmental Assessment (EA) is to be prepared by the project sponsor to determine if an Environmental Impact Statement (EIS) is needed. Further coordination with FHWA is required
- EIS: Based on the information provided by the project sponsor in this form and in accordance with 23 CFR 771, an Environmental Impact Statement (EIS) is to be prepared by the project sponsor. Further coordination with FHWA is required.

COMMENTS

SIGNATURE

TITLE

PRINTED NAME

DATE

Have you ever served on active duty in the Armed Forces of the United States and separated from such service under conditions other than dishonorable? YES NO

APPENDIX B. REAL PROPERTY ACQUISITION DOCUMENTATION CHECKLIST

The following items are required documents to indicate compliance with Uniform Relocation Assistance and Real Property Acquisition Policies Act of 1970, as amended. Please submit **one copy** of each item to the Grants Management Section (GMS), at the address below. Use this checklist to ensure that you've included all required documentation.

RTP Planner
Grants Management Section
Missouri State Parks
PO Box 176
Jefferson City, MO 65102-0176

- Title Search/Title Clearance Report** identifying owner of the property, any liens or restrictions on the property, or any rights or interests held by others. Original to be kept by the project sponsor, with a copy sent to GMS.
- Notice of Interest** in real property sent to the landowner, with a copy of the letter retained by the project sponsor and a copy sent to GMS. The letter must include a statement of landowner and tenant rights. For compliance with the Uniform Act and all applicable state and local requirements, the sponsor should enclose copies of the following booklets provided by the Federal Highway Administration, as appropriate: "Acquisition: Acquiring Real Property for Federal and Federal-Aid Programs and Projects" (http://www.fhwa.dot.gov/real_estate/uniform_act/acquisition/acquisition.pdf) and "Relocation: Your Rights and Benefits as a Displaced Person under the Federal Relocation Assistance Program" (https://www.fhwa.dot.gov/real_estate/publications/your_rights/rights2014.pdf.)
- Appraisal Report or Waiver Valuation**, the original retained by the sponsor, a copy given to the landowner and a copy sent to GMS. Property that is valued less than \$10,000 may not require an appraisal and may only require a waiver valuation. A sample Waiver Valuation is provided in this appendix. Make sure to keep a copy of your proof of delivery (i.e. certified mail card).
- Review Appraisal Report** by a certified review appraiser. The original should be retained by the project sponsor and a copy sent to the landowner and GMS.
- Written Offer of Just Compensation** and all required attachments sent to the landowner, with a copy kept by the project sponsor and a copy sent to GMS. A sample Offer of Just Compensation is provided in this appendix.
- Written Statement of Just Compensation** sent to the landowner, with a copy kept by the sponsor and a copy sent to GMS. A sample is provided in this appendix.
- Waiver of Right to Just Compensation** signed by the landowner, indicating voluntary donation of the property, either in part or a full donation. A sample is provided in this appendix. Signed originals should be kept by the sponsor and the landowner, with a copy sent to GMS.
- Statement of Justification of Difference in Value** must be submitted to GMS, when the negotiated price is more than the approved appraised value. This statement should relay the history of negotiations between the sponsor and the landowner, the importance of the proposed purchase as opposed to alternative sites, or other justification regarding the need to purchase the property at higher than appraised value.

**NOTICE OF INTEREST
(SAMPLE)**

Date

Name of Landowner

Address

City, State ZIP

Dear _____ *(Name of Landowner)*,

On behalf of _____ *(Name of Project Sponsor)*, I am writing to inform you of our interest in acquiring the property located at _____ *(Address of Property)*, further described as _____ *(Legal Description of Property)*. Our records indicate the property is owned by _____ *(Name of Landowner)*. Acquiring the property will allow us to develop _____ *(Name of Project)*.

We have received funds through the Federal Highway Administration's (FHWA) Recreational Trails Program (RTP) to develop this project. Because federal funds are being used for the project, it is subject to the Uniform Relocation Assistance and Real Property Acquisition Policies Act of 1970, as amended. To help you understand your rights under the act, we have enclosed two informational booklets. Under the act, you are entitled to just compensation based on the fair market value of your property. Additionally, you and any tenant currently on the property may be eligible for relocation assistance. And, because RTP regulations prohibit property condemnation of any kind, your property will not be condemned if you do not wish to enter negotiations for the acquisition of your property.

We are hopeful that, because of the benefits to be derived from the project, we can reach an agreement with you to acquire the land and/or property rights needed to accomplish the project, either through purchase, lease, easement or donation. If you would be interested in discussing acquisition options, please contact _____ *(Name of Project Sponsor's Representative)* at _____ *(Phone Number/Email Address)*. He/She will outline the next steps of the process. If you need assistance reading or understanding this notice, [Name of Project Sponsor] will provide appropriate translation and counseling to you. To request this assistance, or if you have questions or would like additional information, please contact me at the phone number and email listed above.

Thank you very much for your consideration of our proposal.

Sincerely,

Signature of Project Sponsor's Authorized Representative

Title of Project Sponsor's Authorized Representative

c: RTP Planner, Missouri Department of Natural Resources, Division of State Parks

Enclosures: "Acquisition: Acquiring Real Property for Federal and Federal-Aid Programs and Projects"
"Relocation: Your Rights and Benefits as a Displaced Person under the Federal Relocation Assistance Program"

**WAIVER VALUATION
(SAMPLE)**

Project Name _____
Parcel Address _____
Parcel Number _____
County _____

Property Owner _____
Owner's Address _____

Date Owner Invited To Accompany Person _____
Assessing Value: _____

Identification of Property _____

Lot: _____ Zoning: _____ Area _____ Sq. Ft.: _____ Acres: _____

Past Sales of Property (5 years): _____

Improvements to Property since Last Sale:

Description of Acquisition : _____

Calculation of Value of Land to be Acquired:

Land: _____ acres at \$_____/per acres = \$_____

Basis for Value:

Calculation of Value of Improvements to be Acquired:

Type of Improvement: _____ = \$_____

Type of Improvement: _____ = \$_____

Type of Improvement: _____ = \$_____

Basis for Value:

Final Value Estimate:

Land Value \$_____ + Value of Improvements \$_____ = \$_____

Prepared by: _____

Date: _____

Signature of Preparer: _____

Required Attachments:

Site Plan

Photograph of Acquisition Area

Comparable Sale or Other Value Support

**WRITTEN OFFER OF JUST COMPENSATION
(SAMPLE)**

Certified Mail Receipt Number:

Date

Name of Landowner

Address

City, State ZIP

Dear _____ *(Name of Landowner)*,

On behalf of _____ *(Name of Project Sponsor)*, I am writing this Offer of Just Compensation for the property located at _____ *(Address of Property)*, further described as _____ *(Legal Description of Property)*.

We have had the property appraised by a licensed appraiser and this report has been thoroughly analyzed by a certified review appraiser and found to be well-supported. Please find enclosed a copy of the appraisal and appraisal review. A Statement of Just Compensation is also enclosed, that provides the basis for the Offer of Just Compensation. Based on the appraisal and review, _____ *(Name of Project Sponsor)* hereby makes you an offer in the amount of \$ _____ *(Appraised Value)* for the purchase of your property. Relocation benefits to which you may be entitled are in addition to the acquisition price of your property.

If this offer meets with your approval, or if you have any questions, please contact _____ *(Name of Project Sponsor's Representative)* at _____ *(Phone Number/Email Address)*. Our staff has prepared _____ *(Description of Conveyance Documents)* to assist in finalizing the acquisition.

Thank you very much for your cooperation and favorable consideration of this offer.

Sincerely,

Signature of Project Sponsor's Authorized Representative

Title of Project Sponsor's Authorized Representative

c: RTP Planner, Missouri Department of Natural Resources, Division of State Parks

Enclosure: Appraisal Report
Appraisal Review Report
Statement of Just Compensation

**WRITTEN STATEMENT OF JUST COMPENSATION
(SAMPLE)**

Description and Location of Property

(Name of Project Sponsor) proposes to purchase land and improvements on (Legal Description of Property) from owner at (Address of Landowner).

Purpose of Purchase

(Name of Project Sponsor) intends to use the parcel for construction of (Name of Project).

Improvements

(Provide a description of the physical setting and improvements, buildings, etc., on the property.)

Declaration of Offer

Based on an appraisal by a licensed appraiser and an appraisal review by a certified review appraiser, (Name of Project Sponsor) hereby makes an offer in the amount of \$ (Appraised Value) for the purchase of said property. This offer is for the fair market value of the property and does not include any considerations of decrease or increase in value attributable to the project for which it is being acquired. It reflects no relocation payments which the owner/tenant may be entitled to receive under Uniform Relocation Assistance and Real Property Acquisition Policies Act of 1970, as amended.

Definition of Fair Market Value

“Fair Market Value is the highest price estimated in terms of money which the property would bring if exposed for sale in the open market, allowing a reasonable time in which to find a purchaser buying with knowledge of all the uses and purposes for which it is adapted and for which it is capable of being used.”

Appraisal Techniques

The following techniques were utilized to determine the fair market value of this property.

(List the techniques used by the appraiser to determine fair market value, such as Cost Approach, Sales Comparison Approach, and Value Estimate by the Income Capitalization Approach.)

Final Estimate of Value

(Provide an explanation of how the appraiser arrived at the final opinion of value and how the results of each approach were weighed in that opinion, and the reliability of each approach to this particular piece of property. The final estimate of value should be a single amount that reflects all contributing values of the property from improvements, etc.)

**WAIVER OF RIGHT TO JUST COMPENSATION
(SAMPLE)**

WAIVER OF ACQUISITION RIGHTS AND BENEFITS UNDER THE FINAL GOVERNMENT-WIDE RULE IMPLEMENTING THE UNIFORM RELOCATION ASSISTANCE AND REAL PROPERTY ACQUISITION POLICIES ACT OF 1970, AS AMENDED.

I, _____ have been informed of my rights to receive just compensation for the portion
(Owner's Name)
of my property which will be used by _____ to construct _____
(Govt. Agency or Organization) *(Project Name)*
in the _____
(Project Area)

I have received a copy of "Acquisition: Acquiring Real Property for Federal and Federal-Aid Programs and Projects" and "Relocation: Your Rights and Benefits as a Displaced Person under the Federal Relocation Assistance Program" and was contacted by a representative of _____ on _____
(Govt. Agency or Organization) *(Date)*
to outline my rights under the Uniform Act, including my right to have the property appraised at no cost to me; my right to accompany the appraiser during this process; and my right to receive Just Compensation based upon the appraisal or valuation process. I was also given the opportunity to discuss any concerns I might have regarding the information I have been provided. I have received a copy of the plat which identifies my property and I understand which portion of my land I will be donating to the _____
(Govt. Agency or Organization)

I have determined that is in my best interest to waive all or a portion of my acquisition rights and benefits accruing to me under the Uniform Act, and prefer to donate an easement or donate my land as described below.

Easement or Land Description _____
Or Partial Land Donation _____

Let it be known that by signature hereon, I freely and without duress waive any and all rights accruing to me for a purchase under the Uniform Act.

Signature of Owner(s):

Name of Owner(s):

Address of Owner(s):

Plat #: _____ Date: _____

**REQUIRED CONTRACT PROVISIONS
FEDERAL-AID CONSTRUCTION CONTRACTS**

- I. General
- II. Nondiscrimination
- III. Non-segregated Facilities
- IV. Davis-Bacon and Related Act Provisions
- V. Contract Work Hours and Safety Standards Act Provisions
- VI. Subletting or Assigning the Contract
- VII. Safety: Accident Prevention
- VIII. False Statements Concerning Highway Projects
- IX. Implementation of Clean Air Act and Federal Water Pollution Control Act
- X. Certification Regarding Debarment, Suspension, Ineligibility and Voluntary Exclusion
- XI. Certification Regarding Use of Contract Funds for Lobbying
- XII. Use of United States-Flag Vessels:

ATTACHMENTS

A. Employment and Materials Preference for Appalachian Development Highway System or Appalachian Local Access Road Contracts (included in Appalachian contracts only)

I. GENERAL

1. Form FHWA-1273 must be physically incorporated in each construction contract funded under title 23, United States Code, as required in 23 CFR 633.102(b) (excluding emergency contracts solely intended for debris removal). The contractor (or subcontractor) must insert this form in each subcontract and further require its inclusion in all lower tier subcontracts (excluding purchase orders, rental agreements and other agreements for supplies or services). 23 CFR 633.102(e).

The applicable requirements of Form FHWA-1273 are incorporated by reference for work done under any purchase order, rental agreement or agreement for other services. The prime contractor shall be responsible for compliance by any subcontractor, lower-tier subcontractor or service provider. 23 CFR 633.102(e).

Form FHWA-1273 must be included in all Federal-aid design-build contracts, in all subcontracts and in lower tier subcontracts (excluding subcontracts for design services, purchase orders, rental agreements and other agreements for supplies or services) in accordance with 23 CFR 633.102. The design-builder shall be responsible for compliance by any subcontractor, lower-tier subcontractor or service provider.

Contracting agencies may reference Form FHWA-1273 in solicitation-for-bids or request-for-proposals documents, however, the Form FHWA-1273 must be physically incorporated (not referenced) in all contracts, subcontracts and lower-tier subcontracts (excluding purchase orders, rental agreements and other agreements for supplies or services related to a construction contract). 23 CFR 633.102(b).

2. Subject to the applicability criteria noted in the following sections, these contract provisions shall apply to all work

performed on the contract by the contractor's own organization and with the assistance of workers under the contractor's immediate superintendence and to all work performed on the contract by piecework, station work, or by subcontract. 23 CFR 633.102(d).

3. A breach of any of the stipulations contained in these Required Contract Provisions may be sufficient grounds for withholding of progress payments, withholding of final payment, termination of the contract, suspension / debarment or any other action determined to be appropriate by the contracting agency and FHWA.

4. Selection of Labor: During the performance of this contract, the contractor shall not use convict labor for any purpose within the limits of a construction project on a Federal-aid highway unless it is labor performed by convicts who are on parole, supervised release, or probation. 23 U.S.C. 114(b). The term Federal-aid highway does not include roadways functionally classified as local roads or rural minor collectors. 23 U.S.C. 101(a).

II. NONDISCRIMINATION (23 CFR 230.107(a); 23 CFR Part 230, Subpart A, Appendix A; EO 11246)

The provisions of this section related to 23 CFR Part 230, Subpart A, Appendix A are applicable to all Federal-aid construction contracts and to all related construction subcontracts of \$10,000 or more. The provisions of 23 CFR Part 230 are not applicable to material supply, engineering, or architectural service contracts.

In addition, the contractor and all subcontractors must comply with the following policies: Executive Order 11246, 41 CFR Part 60, 29 CFR Parts 1625-1627, 23 U.S.C. 140, Section 504 of the Rehabilitation Act of 1973, as amended (29 U.S.C. 794), Title VI of the Civil Rights Act of 1964, as amended (42 U.S.C. 2000d et seq.), and related regulations including 49 CFR Parts 21, 26, and 27; and 23 CFR Parts 200, 230, and 633.

The contractor and all subcontractors must comply with: the requirements of the Equal Opportunity Clause in 41 CFR 60-1.4(b) and, for all construction contracts exceeding \$10,000, the Standard Federal Equal Employment Opportunity Construction Contract Specifications in 41 CFR 60-4.3.

Note: The U.S. Department of Labor has exclusive authority to determine compliance with Executive Order 11246 and the policies of the Secretary of Labor including 41 CFR Part 60, and 29 CFR Parts 1625-1627. The contracting agency and the FHWA have the authority and the responsibility to ensure compliance with 23 U.S.C. 140, Section 504 of the Rehabilitation Act of 1973, as amended (29 U.S.C. 794), and Title VI of the Civil Rights Act of 1964, as amended (42 U.S.C. 2000d et seq.), and related regulations including 49 CFR Parts 21, 26, and 27; and 23 CFR Parts 200, 230, and 633.

The following provision is adopted from 23 CFR Part 230, Subpart A, Appendix A, with appropriate revisions to conform to the U.S. Department of Labor (US DOL) and FHWA requirements.

1. Equal Employment Opportunity: Equal Employment Opportunity (EEO) requirements not to discriminate and to take affirmative action to assure equal opportunity as set forth under laws, executive orders, rules, regulations (see 28 CFR Part 35, 29 CFR Part 1630, 29 CFR Parts 1625-1627, 41 CFR Part 60 and 49 CFR Part 27) and orders of the Secretary of Labor as modified by the provisions prescribed herein, and imposed pursuant to 23 U.S.C. 140, shall constitute the EEO and specific affirmative action standards for the contractor's project activities under this contract. The provisions of the Americans with Disabilities Act of 1990 (42 U.S.C. 12101 et seq.) set forth under 28 CFR Part 35 and 29 CFR Part 1630 are incorporated by reference in this contract. In the execution of this contract, the contractor agrees to comply with the following minimum specific requirement activities of EEO:

a. The contractor will work with the contracting agency and the Federal Government to ensure that it has made every good faith effort to provide equal opportunity with respect to all of its terms and conditions of employment and in their review of activities under the contract. 23 CFR 230.409 (g)(4) & (5).

b. The contractor will accept as its operating policy the following statement:

"It is the policy of this Company to assure that applicants are employed, and that employees are treated during employment, without regard to their race, religion, sex, sexual orientation, gender identity, color, national origin, age or disability. Such action shall include: employment, upgrading, demotion, or transfer; recruitment or recruitment advertising; layoff or termination; rates of pay or other forms of compensation; and selection for training, including apprenticeship, pre-apprenticeship, and/or on-the-job training."

2. EEO Officer: The contractor will designate and make known to the contracting officers an EEO Officer who will have the responsibility for and must be capable of effectively administering and promoting an active EEO program and who must be assigned adequate authority and responsibility to do so.

3. Dissemination of Policy: All members of the contractor's staff who are authorized to hire, supervise, promote, and discharge employees, or who recommend such action or are substantially involved in such action, will be made fully cognizant of and will implement the contractor's EEO policy and contractual responsibilities to provide EEO in each grade and classification of employment. To ensure that the above agreement will be met, the following actions will be taken as a minimum:

a. Periodic meetings of supervisory and personnel office employees will be conducted before the start of work and then not less often than once every six months, at which time the contractor's EEO policy and its implementation will be reviewed and explained. The meetings will be conducted by the EEO Officer or other knowledgeable company official.

b. All new supervisory or personnel office employees will be given a thorough indoctrination by the EEO Officer, covering all major aspects of the contractor's EEO obligations within thirty days following their reporting for duty with the contractor.

c. All personnel who are engaged in direct recruitment for the project will be instructed by the EEO Officer in the contractor's procedures for locating and hiring minorities and women.

d. Notices and posters setting forth the contractor's EEO policy will be placed in areas readily accessible to employees, applicants for employment and potential employees.

e. The contractor's EEO policy and the procedures to implement such policy will be brought to the attention of employees by means of meetings, employee handbooks, or other appropriate means.

4. Recruitment: When advertising for employees, the contractor will include in all advertisements for employees the notation: "An Equal Opportunity Employer." All such advertisements will be placed in publications having a large circulation among minorities and women in the area from which the project work force would normally be derived.

a. The contractor will, unless precluded by a valid bargaining agreement, conduct systematic and direct recruitment through public and private employee referral sources likely to yield qualified minorities and women. To meet this requirement, the contractor will identify sources of potential minority group employees and establish with such identified sources procedures whereby minority and women applicants may be referred to the contractor for employment consideration.

b. In the event the contractor has a valid bargaining agreement providing for exclusive hiring hall referrals, the contractor is expected to observe the provisions of that agreement to the extent that the system meets the contractor's compliance with EEO contract provisions. Where implementation of such an agreement has the effect of discriminating against minorities or women, or obligates the contractor to do the same, such implementation violates Federal nondiscrimination provisions.

c. The contractor will encourage its present employees to refer minorities and women as applicants for employment. Information and procedures with regard to referring such applicants will be discussed with employees.

5. Personnel Actions: Wages, working conditions, and employee benefits shall be established and administered, and personnel actions of every type, including hiring, upgrading, promotion, transfer, demotion, layoff, and termination, shall be taken without regard to race, color, religion, sex, sexual orientation, gender identity, national origin, age or disability. The following procedures shall be followed:

a. The contractor will conduct periodic inspections of project sites to ensure that working conditions and employee facilities do not indicate discriminatory treatment of project site personnel.

b. The contractor will periodically evaluate the spread of wages paid within each classification to determine any evidence of discriminatory wage practices.

c. The contractor will periodically review selected personnel actions in depth to determine whether there is evidence of discrimination. Where evidence is found, the contractor will promptly take corrective action. If the review indicates that the discrimination may extend beyond the actions reviewed, such corrective action shall include all affected persons.

d. The contractor will promptly investigate all complaints of alleged discrimination made to the contractor in connection with its obligations under this contract, will attempt to resolve such complaints, and will take appropriate corrective action

within a reasonable time. If the investigation indicates that the discrimination may affect persons other than the complainant, such corrective action shall include such other persons. Upon completion of each investigation, the contractor will inform every complainant of all of their avenues of appeal.

6. Training and Promotion:

a. The contractor will assist in locating, qualifying, and increasing the skills of minorities and women who are applicants for employment or current employees. Such efforts should be aimed at developing full journey level status employees in the type of trade or job classification involved.

b. Consistent with the contractor's work force requirements and as permissible under Federal and State regulations, the contractor shall make full use of training programs (i.e., apprenticeship and on-the-job training programs for the geographical area of contract performance). In the event a special provision for training is provided under this contract, this subparagraph will be superseded as indicated in the special provision. The contracting agency may reserve training positions for persons who receive welfare assistance in accordance with 23 U.S.C. 140(a).

c. The contractor will advise employees and applicants for employment of available training programs and entrance requirements for each.

d. The contractor will periodically review the training and promotion potential of employees who are minorities and women and will encourage eligible employees to apply for such training and promotion.

7. Unions: If the contractor relies in whole or in part upon unions as a source of employees, the contractor will use good faith efforts to obtain the cooperation of such unions to increase opportunities for minorities and women. 23 CFR 230.409. Actions by the contractor, either directly or through a contractor's association acting as agent, will include the procedures set forth below:

a. The contractor will use good faith efforts to develop, in cooperation with the unions, joint training programs aimed toward qualifying more minorities and women for membership in the unions and increasing the skills of minorities and women so that they may qualify for higher paying employment.

b. The contractor will use good faith efforts to incorporate an EEO clause into each union agreement to the end that such union will be contractually bound to refer applicants without regard to their race, color, religion, sex, sexual orientation, gender identity, national origin, age, or disability.

c. The contractor is to obtain information as to the referral practices and policies of the labor union except that to the extent such information is within the exclusive possession of the labor union and such labor union refuses to furnish such information to the contractor, the contractor shall so certify to the contracting agency and shall set forth what efforts have been made to obtain such information.

d. In the event the union is unable to provide the contractor with a reasonable flow of referrals within the time limit set forth in the collective bargaining agreement, the contractor will, through independent recruitment efforts, fill the employment vacancies without regard to race, color, religion, sex, sexual orientation, gender identity, national origin, age, or disability; making full efforts to obtain qualified and/or qualifiable minorities and women. The failure of a union to provide

sufficient referrals (even though it is obligated to provide exclusive referrals under the terms of a collective bargaining agreement) does not relieve the contractor from the requirements of this paragraph. In the event the union referral practice prevents the contractor from meeting the obligations pursuant to Executive Order 11246, as amended, and these special provisions, such contractor shall immediately notify the contracting agency.

8. Reasonable Accommodation for Applicants / Employees with Disabilities: The contractor must be familiar with the requirements for and comply with the Americans with Disabilities Act and all rules and regulations established thereunder. Employers must provide reasonable accommodation in all employment activities unless to do so would cause an undue hardship.

9. Selection of Subcontractors, Procurement of Materials and Leasing of Equipment: The contractor shall not discriminate on the grounds of race, color, religion, sex, sexual orientation, gender identity, national origin, age, or disability in the selection and retention of subcontractors, including procurement of materials and leases of equipment. The contractor shall take all necessary and reasonable steps to ensure nondiscrimination in the administration of this contract.

a. The contractor shall notify all potential subcontractors, suppliers, and lessors of their EEO obligations under this contract.

b. The contractor will use good faith efforts to ensure subcontractor compliance with their EEO obligations.

10. Assurances Required:

a. The requirements of 49 CFR Part 26 and the State DOT's FHWA-approved Disadvantaged Business Enterprise (DBE) program are incorporated by reference.

b. The contractor, subrecipient or subcontractor shall not discriminate on the basis of race, color, national origin, or sex in the performance of this contract. The contractor shall carry out applicable requirements of 49 CFR part 26 in the award and administration of DOT-assisted contracts. Failure by the contractor to carry out these requirements is a material breach of this contract, which may result in the termination of this contract or such other remedy as the recipient deems appropriate, which may include, but is not limited to:

- (1) Withholding monthly progress payments;
- (2) Assessing sanctions;
- (3) Liquidated damages; and/or
- (4) Disqualifying the contractor from future bidding as non-responsible.

c. The Title VI and nondiscrimination provisions of U.S. DOT Order 1050.2A at Appendixes A and E are incorporated by reference. 49 CFR Part 21.

11. Records and Reports: The contractor shall keep such records as necessary to document compliance with the EEO requirements. Such records shall be retained for a period of three years following the date of the final payment to the contractor for all contract work and shall be available at reasonable times and places for inspection by authorized representatives of the contracting agency and the FHWA.

a. The records kept by the contractor shall document the following:

(1) The number and work hours of minority and non-minority group members and women employed in each work classification on the project;

(2) The progress and efforts being made in cooperation with unions, when applicable, to increase employment opportunities for minorities and women; and

(3) The progress and efforts being made in locating, hiring, training, qualifying, and upgrading minorities and women.

b. The contractors and subcontractors will submit an annual report to the contracting agency each July for the duration of the project indicating the number of minority, women, and non-minority group employees currently engaged in each work classification required by the contract work. This information is to be reported on [Form FHWA-1391](#). The staffing data should represent the project work force on board in all or any part of the last payroll period preceding the end of July. If on-the-job training is being required by special provision, the contractor will be required to collect and report training data. The employment data should reflect the work force on board during all or any part of the last payroll period preceding the end of July.

III. NONSEGREGATED FACILITIES

This provision is applicable to all Federal-aid construction contracts and to all related construction subcontracts of more than \$10,000. 41 CFR 60-1.5.

As prescribed by 41 CFR 60-1.8, the contractor must ensure that facilities provided for employees are provided in such a manner that segregation on the basis of race, color, religion, sex, sexual orientation, gender identity, or national origin cannot result. The contractor may neither require such segregated use by written or oral policies nor tolerate such use by employee custom. The contractor's obligation extends further to ensure that its employees are not assigned to perform their services at any location under the contractor's control where the facilities are segregated. The term "facilities" includes waiting rooms, work areas, restaurants and other eating areas, time clocks, restrooms, washrooms, locker rooms and other storage or dressing areas, parking lots, drinking fountains, recreation or entertainment areas, transportation, and housing provided for employees. The contractor shall provide separate or single-user restrooms and necessary dressing or sleeping areas to assure privacy between sexes.

IV. DAVIS-BACON AND RELATED ACT PROVISIONS

This section is applicable to all Federal-aid construction projects exceeding \$2,000 and to all related subcontracts and lower-tier subcontracts (regardless of subcontract size), in accordance with 29 CFR 5.5. The requirements apply to all projects located within the right-of-way of a roadway that is functionally classified as Federal-aid highway. 23 U.S.C. 113. This excludes roadways functionally classified as local roads or rural minor collectors, which are exempt. 23 U.S.C. 101. Where applicable law requires that projects be treated as a project on a Federal-aid highway, the provisions of this subpart will apply regardless of the location of the project. Examples include: Surface Transportation Block Grant Program projects funded under 23 U.S.C. 133 [excluding recreational trails projects], the Nationally Significant Freight and Highway

Projects funded under 23 U.S.C. 117, and National Highway Freight Program projects funded under 23 U.S.C. 167.

The following provisions are from the U.S. Department of Labor regulations in 29 CFR 5.5 "Contract provisions and related matters" with minor revisions to conform to the FHWA-1273 format and FHWA program requirements.

1. Minimum wages (29 CFR 5.5)

a. *Wage rates and fringe benefits.* All laborers and mechanics employed or working upon the site of the work (or otherwise working in construction or development of the project under a development statute), will be paid unconditionally and not less often than once a week, and without subsequent deduction or rebate on any account (except such payroll deductions as are permitted by regulations issued by the Secretary of Labor under the Copeland Act ([29 CFR part 3](#))), the full amount of basic hourly wages and bona fide fringe benefits (or cash equivalents thereof) due at time of payment computed at rates not less than those contained in the wage determination of the Secretary of Labor which is attached hereto and made a part hereof, regardless of any contractual relationship which may be alleged to exist between the contractor and such laborers and mechanics. As provided in paragraphs (d) and (e) of 29 CFR 5.5, the appropriate wage determinations are effective by operation of law even if they have not been attached to the contract. Contributions made or costs reasonably anticipated for bona fide fringe benefits under the Davis-Bacon Act ([40 U.S.C. 3141\(2\)\(B\)](#)) on behalf of laborers or mechanics are considered wages paid to such laborers or mechanics, subject to the provisions of paragraph 1.e. of this section; also, regular contributions made or costs incurred for more than a weekly period (but not less often than quarterly) under plans, funds, or programs which cover the particular weekly period, are deemed to be constructively made or incurred during such weekly period. Such laborers and mechanics must be paid the appropriate wage rate and fringe benefits on the wage determination for the classification(s) of work actually performed, without regard to skill, except as provided in paragraph 4. of this section. Laborers or mechanics performing work in more than one classification may be compensated at the rate specified for each classification for the time actually worked therein: *Provided*, That the employer's payroll records accurately set forth the time spent in each classification in which work is performed. The wage determination (including any additional classifications and wage rates conformed under paragraph 1.c. of this section) and the Davis-Bacon poster (WH-1321) must be posted at all times by the contractor and its subcontractors at the site of the work in a prominent and accessible place where it can be easily seen by the workers.

b. *Frequently recurring classifications.* (1) In addition to wage and fringe benefit rates that have been determined to be prevailing under the procedures set forth in [29 CFR part 1](#), a wage determination may contain, pursuant to § 1.3(f), wage and fringe benefit rates for classifications of laborers and mechanics for which conformance requests are regularly submitted pursuant to paragraph 1.c. of this section, provided that:

(i) The work performed by the classification is not performed by a classification in the wage determination for which a prevailing wage rate has been determined;

(ii) The classification is used in the area by the construction industry; and

(iii) The wage rate for the classification bears a reasonable relationship to the prevailing wage rates contained in the wage determination.

(2) The Administrator will establish wage rates for such classifications in accordance with paragraph 1.c.(1)(iii) of this section. Work performed in such a classification must be paid at no less than the wage and fringe benefit rate listed on the wage determination for such classification.

c. *Conformance.* (1) The contracting officer must require that any class of laborers or mechanics, including helpers, which is not listed in the wage determination and which is to be employed under the contract be classified in conformance with the wage determination. Conformance of an additional classification and wage rate and fringe benefits is appropriate only when the following criteria have been met:

(i) The work to be performed by the classification requested is not performed by a classification in the wage determination; and

(ii) The classification is used in the area by the construction industry; and

(iii) The proposed wage rate, including any bona fide fringe benefits, bears a reasonable relationship to the wage rates contained in the wage determination.

(2) The conformance process may not be used to split, subdivide, or otherwise avoid application of classifications listed in the wage determination.

(3) If the contractor and the laborers and mechanics to be employed in the classification (if known), or their representatives, and the contracting officer agree on the classification and wage rate (including the amount designated for fringe benefits where appropriate), a report of the action taken will be sent by the contracting officer by email to DBAconformance@dol.gov. The Administrator, or an authorized representative, will approve, modify, or disapprove every additional classification action within 30 days of receipt and so advise the contracting officer or will notify the contracting officer within the 30-day period that additional time is necessary.

(4) In the event the contractor, the laborers or mechanics to be employed in the classification or their representatives, and the contracting officer do not agree on the proposed classification and wage rate (including the amount designated for fringe benefits, where appropriate), the contracting officer will, by email to DBAconformance@dol.gov, refer the questions, including the views of all interested parties and the recommendation of the contracting officer, to the Administrator for determination. The Administrator, or an authorized representative, will issue a determination within 30 days of receipt and so advise the contracting officer or will notify the contracting officer within the 30-day period that additional time is necessary.

(5) The contracting officer must promptly notify the contractor of the action taken by the Wage and Hour Division

under paragraphs 1.c.(3) and (4) of this section. The contractor must furnish a written copy of such determination to each affected worker or it must be posted as a part of the wage determination. The wage rate (including fringe benefits where appropriate) determined pursuant to paragraph 1.c.(3) or (4) of this section must be paid to all workers performing work in the classification under this contract from the first day on which work is performed in the classification.

d. *Fringe benefits not expressed as an hourly rate.* Whenever the minimum wage rate prescribed in the contract for a class of laborers or mechanics includes a fringe benefit which is not expressed as an hourly rate, the contractor may either pay the benefit as stated in the wage determination or may pay another bona fide fringe benefit or an hourly cash equivalent thereof.

e. *Unfunded plans.* If the contractor does not make payments to a trustee or other third person, the contractor may consider as part of the wages of any laborer or mechanic the amount of any costs reasonably anticipated in providing bona fide fringe benefits under a plan or program, *Provided*, That the Secretary of Labor has found, upon the written request of the contractor, in accordance with the criteria set forth in § 5.28, that the applicable standards of the Davis-Bacon Act have been met. The Secretary of Labor may require the contractor to set aside in a separate account assets for the meeting of obligations under the plan or program.

f. *Interest.* In the event of a failure to pay all or part of the wages required by the contract, the contractor will be required to pay interest on any underpayment of wages.

2. Withholding (29 CFR 5.5)

a. *Withholding requirements.* The contracting agency may, upon its own action, or must, upon written request of an authorized representative of the Department of Labor, withhold or cause to be withheld from the contractor so much of the accrued payments or advances as may be considered necessary to satisfy the liabilities of the prime contractor or any subcontractor for the full amount of wages and monetary relief, including interest, required by the clauses set forth in this section for violations of this contract, or to satisfy any such liabilities required by any other Federal contract, or federally assisted contract subject to Davis-Bacon labor standards, that is held by the same prime contractor (as defined in § 5.2). The necessary funds may be withheld from the contractor under this contract, any other Federal contract with the same prime contractor, or any other federally assisted contract that is subject to Davis-Bacon labor standards requirements and is held by the same prime contractor, regardless of whether the other contract was awarded or assisted by the same agency, and such funds may be used to satisfy the contractor liability for which the funds were withheld. In the event of a contractor's failure to pay any laborer or mechanic, including any apprentice or helper working on the site of the work all or part of the wages required by the contract, or upon the contractor's failure to submit the required records as discussed in paragraph 3.d. of this section, the contracting agency may on its own initiative and after written notice to the contractor, take such action as may be necessary to cause the suspension of any further payment, advance, or guarantee of funds until such violations have ceased.

b. *Priority to withheld funds.* The Department has priority to funds withheld or to be withheld in accordance with paragraph

2.a. of this section or Section V, paragraph 3.a., or both, over claims to those funds by:

- (1) A contractor's surety(ies), including without limitation performance bond sureties and payment bond sureties;
- (2) A contracting agency for its procurement costs;
- (3) A trustee(s) (either a court-appointed trustee or a U.S. trustee, or both) in bankruptcy of a contractor, or a contractor's bankruptcy estate;
- (4) A contractor's assignee(s);
- (5) A contractor's successor(s); or
- (6) A claim asserted under the Prompt Payment Act, [31 U.S.C. 3901–3907](#).

3. Records and certified payrolls (29 CFR 5.5)

a. *Basic record requirements (1) Length of record retention.* All regular payrolls and other basic records must be maintained by the contractor and any subcontractor during the course of the work and preserved for all laborers and mechanics working at the site of the work (or otherwise working in construction or development of the project under a development statute) for a period of at least 3 years after all the work on the prime contract is completed.

(2) *Information required.* Such records must contain the name; Social Security number; last known address, telephone number, and email address of each such worker; each worker's correct classification(s) of work actually performed; hourly rates of wages paid (including rates of contributions or costs anticipated for bona fide fringe benefits or cash equivalents thereof of the types described in [40 U.S.C. 3141\(2\)\(B\)](#) of the Davis-Bacon Act); daily and weekly number of hours actually worked in total and on each covered contract; deductions made; and actual wages paid.

(3) *Additional records relating to fringe benefits.* Whenever the Secretary of Labor has found under paragraph 1.e. of this section that the wages of any laborer or mechanic include the amount of any costs reasonably anticipated in providing benefits under a plan or program described in [40 U.S.C. 3141\(2\)\(B\)](#) of the Davis-Bacon Act, the contractor must maintain records which show that the commitment to provide such benefits is enforceable, that the plan or program is financially responsible, and that the plan or program has been communicated in writing to the laborers or mechanics affected, and records which show the costs anticipated or the actual cost incurred in providing such benefits.

(4) *Additional records relating to apprenticeship.* Contractors with apprentices working under approved programs must maintain written evidence of the registration of apprenticeship programs, the registration of the apprentices, and the ratios and wage rates prescribed in the applicable programs.

b. *Certified payroll requirements (1) Frequency and method of submission.* The contractor or subcontractor must submit weekly, for each week in which any DBA- or Related Acts-covered work is performed, certified payrolls to the contracting

agency. The prime contractor is responsible for the submission of all certified payrolls by all subcontractors. A contracting agency or prime contractor may permit or require contractors to submit certified payrolls through an electronic system, as long as the electronic system requires a legally valid electronic signature; the system allows the contractor, the contracting agency, and the Department of Labor to access the certified payrolls upon request for at least 3 years after the work on the prime contract has been completed; and the contracting agency or prime contractor permits other methods of submission in situations where the contractor is unable or limited in its ability to use or access the electronic system.

(2) *Information required.* The certified payrolls submitted must set out accurately and completely all of the information required to be maintained under paragraph 3.a.(2) of this section, except that full Social Security numbers and last known addresses, telephone numbers, and email addresses must not be included on weekly transmittals. Instead, the certified payrolls need only include an individually identifying number for each worker (e.g., the last four digits of the worker's Social Security number). The required weekly certified payroll information may be submitted using Optional Form WH-347 or in any other format desired. Optional Form WH-347 is available for this purpose from the Wage and Hour Division website at <https://www.dol.gov/sites/dolgov/files/WHD/legacy/files/wh347.pdf> or its successor website. It is not a violation of this section for a prime contractor to require a subcontractor to provide full Social Security numbers and last known addresses, telephone numbers, and email addresses to the prime contractor for its own records, without weekly submission by the subcontractor to the contracting agency.

(3) *Statement of Compliance.* Each certified payroll submitted must be accompanied by a "Statement of Compliance," signed by the contractor or subcontractor, or the contractor's or subcontractor's agent who pays or supervises the payment of the persons working on the contract, and must certify the following:

(i) That the certified payroll for the payroll period contains the information required to be provided under paragraph 3.b. of this section, the appropriate information and basic records are being maintained under paragraph 3.a. of this section, and such information and records are correct and complete;

(ii) That each laborer or mechanic (including each helper and apprentice) working on the contract during the payroll period has been paid the full weekly wages earned, without rebate, either directly or indirectly, and that no deductions have been made either directly or indirectly from the full wages earned, other than permissible deductions as set forth in [29 CFR part 3](#); and

(iii) That each laborer or mechanic has been paid not less than the applicable wage rates and fringe benefits or cash equivalents for the classification(s) of work actually performed, as specified in the applicable wage determination incorporated into the contract.

(4) *Use of Optional Form WH-347.* The weekly submission of a properly executed certification set forth on the reverse side of Optional Form WH-347 will satisfy the requirement for submission of the "Statement of Compliance" required by paragraph 3.b.(3) of this section.

(5) *Signature*. The signature by the contractor, subcontractor, or the contractor's or subcontractor's agent must be an original handwritten signature or a legally valid electronic signature.

(6) *Falsification*. The falsification of any of the above certifications may subject the contractor or subcontractor to civil or criminal prosecution under [18 U.S.C. 1001](#) and [31 U.S.C. 3729](#).

(7) *Length of certified payroll retention*. The contractor or subcontractor must preserve all certified payrolls during the course of the work and for a period of 3 years after all the work on the prime contract is completed.

c. *Contracts, subcontracts, and related documents*. The contractor or subcontractor must maintain this contract or subcontract and related documents including, without limitation, bids, proposals, amendments, modifications, and extensions. The contractor or subcontractor must preserve these contracts, subcontracts, and related documents during the course of the work and for a period of 3 years after all the work on the prime contract is completed.

d. *Required disclosures and access* (1) *Required record disclosures and access to workers*. The contractor or subcontractor must make the records required under paragraphs 3.a. through 3.c. of this section, and any other documents that the contracting agency, the State DOT, the FHWA, or the Department of Labor deems necessary to determine compliance with the labor standards provisions of any of the applicable statutes referenced by § 5.1, available for inspection, copying, or transcription by authorized representatives of the contracting agency, the State DOT, the FHWA, or the Department of Labor, and must permit such representatives to interview workers during working hours on the job.

(2) *Sanctions for non-compliance with records and worker access requirements*. If the contractor or subcontractor fails to submit the required records or to make them available, or refuses to permit worker interviews during working hours on the job, the Federal agency may, after written notice to the contractor, sponsor, applicant, owner, or other entity, as the case may be, that maintains such records or that employs such workers, take such action as may be necessary to cause the suspension of any further payment, advance, or guarantee of funds. Furthermore, failure to submit the required records upon request or to make such records available, or to permit worker interviews during working hours on the job, may be grounds for debarment action pursuant to § 5.12. In addition, any contractor or other person that fails to submit the required records or make those records available to WHD within the time WHD requests that the records be produced will be precluded from introducing as evidence in an administrative proceeding under [29 CFR part 6](#) any of the required records that were not provided or made available to WHD. WHD will take into consideration a reasonable request from the contractor or person for an extension of the time for submission of records. WHD will determine the reasonableness of the request and may consider, among other things, the location of the records and the volume of production.

(3) *Required information disclosures*. Contractors and subcontractors must maintain the full Social Security number and last known address, telephone number, and email address

of each covered worker, and must provide them upon request to the contracting agency, the State DOT, the FHWA, the contractor, or the Wage and Hour Division of the Department of Labor for purposes of an investigation or other compliance action.

4. Apprentices and equal employment opportunity (29 CFR 5.5)

a. *Apprentices* (1) *Rate of pay*. Apprentices will be permitted to work at less than the predetermined rate for the work they perform when they are employed pursuant to and individually registered in a bona fide apprenticeship program registered with the U.S. Department of Labor, Employment and Training Administration, Office of Apprenticeship (OA), or with a State Apprenticeship Agency recognized by the OA. A person who is not individually registered in the program, but who has been certified by the OA or a State Apprenticeship Agency (where appropriate) to be eligible for probationary employment as an apprentice, will be permitted to work at less than the predetermined rate for the work they perform in the first 90 days of probationary employment as an apprentice in such a program. In the event the OA or a State Apprenticeship Agency recognized by the OA withdraws approval of an apprenticeship program, the contractor will no longer be permitted to use apprentices at less than the applicable predetermined rate for the work performed until an acceptable program is approved.

(2) *Fringe benefits*. Apprentices must be paid fringe benefits in accordance with the provisions of the apprenticeship program. If the apprenticeship program does not specify fringe benefits, apprentices must be paid the full amount of fringe benefits listed on the wage determination for the applicable classification. If the Administrator determines that a different practice prevails for the applicable apprentice classification, fringe benefits must be paid in accordance with that determination.

(3) *Apprenticeship ratio*. The allowable ratio of apprentices to journeyworkers on the job site in any craft classification must not be greater than the ratio permitted to the contractor as to the entire work force under the registered program or the ratio applicable to the locality of the project pursuant to paragraph 4.a.(4) of this section. Any worker listed on a payroll at an apprentice wage rate, who is not registered or otherwise employed as stated in paragraph 4.a.(1) of this section, must be paid not less than the applicable wage rate on the wage determination for the classification of work actually performed. In addition, any apprentice performing work on the job site in excess of the ratio permitted under this section must be paid not less than the applicable wage rate on the wage determination for the work actually performed.

(4) *Reciprocity of ratios and wage rates*. Where a contractor is performing construction on a project in a locality other than the locality in which its program is registered, the ratios and wage rates (expressed in percentages of the journeyworker's hourly rate) applicable within the locality in which the construction is being performed must be observed. If there is no applicable ratio or wage rate for the locality of the project, the ratio and wage rate specified in the contractor's registered program must be observed.

b. *Equal employment opportunity*. The use of apprentices and journeyworkers under this part must be in conformity with

the equal employment opportunity requirements of Executive Order 11246, as amended, and [29 CFR part 30](#).

c. Apprentices and Trainees (programs of the U.S. DOT).

Apprentices and trainees working under apprenticeship and skill training programs which have been certified by the Secretary of Transportation as promoting EEO in connection with Federal-aid highway construction programs are not subject to the requirements of paragraph 4 of this Section IV. 23 CFR 230.111(e)(2). The straight time hourly wage rates for apprentices and trainees under such programs will be established by the particular programs. The ratio of apprentices and trainees to journeyworkers shall not be greater than permitted by the terms of the particular program.

5. Compliance with Copeland Act requirements. The contractor shall comply with the requirements of 29 CFR part 3, which are incorporated by reference in this contract as provided in 29 CFR 5.5.

6. Subcontracts. The contractor or subcontractor must insert FHWA-1273 in any subcontracts, along with the applicable wage determination(s) and such other clauses or contract modifications as the contracting agency may by appropriate instructions require, and a clause requiring the subcontractors to include these clauses and wage determination(s) in any lower tier subcontracts. The prime contractor is responsible for the compliance by any subcontractor or lower tier subcontractor with all the contract clauses in this section. In the event of any violations of these clauses, the prime contractor and any subcontractor(s) responsible will be liable for any unpaid wages and monetary relief, including interest from the date of the underpayment or loss, due to any workers of lower-tier subcontractors, and may be subject to debarment, as appropriate. 29 CFR 5.5.

7. Contract termination: debarment. A breach of the contract clauses in 29 CFR 5.5 may be grounds for termination of the contract, and for debarment as a contractor and a subcontractor as provided in 29 CFR 5.12.

8. Compliance with Davis-Bacon and Related Act requirements. All rulings and interpretations of the Davis-Bacon and Related Acts contained in 29 CFR parts 1, 3, and 5 are herein incorporated by reference in this contract as provided in 29 CFR 5.5.

9. Disputes concerning labor standards. As provided in 29 CFR 5.5, disputes arising out of the labor standards provisions of this contract shall not be subject to the general disputes clause of this contract. Such disputes shall be resolved in accordance with the procedures of the Department of Labor set forth in 29 CFR parts 5, 6, and 7. Disputes within the meaning of this clause include disputes between the contractor (or any of its subcontractors) and the contracting agency, the U.S. Department of Labor, or the employees or their representatives.

10. Certification of eligibility. a. By entering into this contract, the contractor certifies that neither it nor any person or firm who has an interest in the contractor's firm is a person or firm ineligible to be awarded Government contracts by virtue of [40 U.S.C. 3144\(b\)](#) or § 5.12(a).

b. No part of this contract shall be subcontracted to any person or firm ineligible for award of a Government contract by virtue of [40 U.S.C. 3144\(b\)](#) or § 5.12(a).

c. The penalty for making false statements is prescribed in the U.S. Code, Title 18 Crimes and Criminal Procedure, [18 U.S.C. 1001](#).

11. Anti-retaliation. It is unlawful for any person to discharge, demote, intimidate, threaten, restrain, coerce, blacklist, harass, or in any other manner discriminate against, or to cause any person to discharge, demote, intimidate, threaten, restrain, coerce, blacklist, harass, or in any other manner discriminate against, any worker or job applicant for:

a. Notifying any contractor of any conduct which the worker reasonably believes constitutes a violation of the DBA, Related Acts, this part, or [29 CFR part 1](#) or [3](#);

b. Filing any complaint, initiating or causing to be initiated any proceeding, or otherwise asserting or seeking to assert on behalf of themselves or others any right or protection under the DBA, Related Acts, this part, or [29 CFR part 1](#) or [3](#);

c. Cooperating in any investigation or other compliance action, or testifying in any proceeding under the DBA, Related Acts, this part, or [29 CFR part 1](#) or [3](#); or

d. Informing any other person about their rights under the DBA, Related Acts, this part, or [29 CFR part 1](#) or [3](#).

V. CONTRACT WORK HOURS AND SAFETY STANDARDS ACT

Pursuant to 29 CFR 5.5(b), the following clauses apply to any Federal-aid construction contract in an amount in excess of \$100,000 and subject to the overtime provisions of the Contract Work Hours and Safety Standards Act. These clauses shall be inserted in addition to the clauses required by 29 CFR 5.5(a) or 29 CFR 4.6. As used in this paragraph, the terms laborers and mechanics include watchpersons and guards.

1. Overtime requirements. No contractor or subcontractor contracting for any part of the contract work which may require or involve the employment of laborers or mechanics shall require or permit any such laborer or mechanic in any workweek in which he or she is employed on such work to work in excess of forty hours in such workweek unless such laborer or mechanic receives compensation at a rate not less than one and one-half times the basic rate of pay for all hours worked in excess of forty hours in such workweek. 29 CFR 5.5.

2. Violation; liability for unpaid wages; liquidated damages. In the event of any violation of the clause set forth in paragraph 1. of this section the contractor and any subcontractor responsible therefor shall be liable for the unpaid wages and interest from the date of the underpayment. In addition, such contractor and subcontractor shall be liable to the United States (in the case of work done under contract for the District of Columbia or a territory, to such District or to such territory), for liquidated damages. Such liquidated damages shall be computed with respect to each individual laborer or

mechanic, including watchpersons and guards, employed in violation of the clause set forth in paragraph 1. of this section, in the sum currently provided in 29 CFR 5.5(b)(2)* for each calendar day on which such individual was required or permitted to work in excess of the standard workweek of forty hours without payment of the overtime wages required by the clause set forth in paragraph 1. of this section.

* \$31 as of January 15, 2023 (See 88 FR 88 FR 2210) as may be adjusted annually by the Department of Labor, pursuant to the Federal Civil Penalties Inflation Adjustment Act of 1990.

3. Withholding for unpaid wages and liquidated damages

a. *Withholding process.* The FHWA or the contracting agency may, upon its own action, or must, upon written request of an authorized representative of the Department of Labor, withhold or cause to be withheld from the contractor so much of the accrued payments or advances as may be considered necessary to satisfy the liabilities of the prime contractor or any subcontractor for any unpaid wages; monetary relief, including interest; and liquidated damages required by the clauses set forth in this section on this contract, any other Federal contract with the same prime contractor, or any other federally assisted contract subject to the Contract Work Hours and Safety Standards Act that is held by the same prime contractor (as defined in § 5.2). The necessary funds may be withheld from the contractor under this contract, any other Federal contract with the same prime contractor, or any other federally assisted contract that is subject to the Contract Work Hours and Safety Standards Act and is held by the same prime contractor, regardless of whether the other contract was awarded or assisted by the same agency, and such funds may be used to satisfy the contractor liability for which the funds were withheld.

b. *Priority to withheld funds.* The Department has priority to funds withheld or to be withheld in accordance with Section IV paragraph 2.a. or paragraph 3.a. of this section, or both, over claims to those funds by:

- (1) A contractor's surety(ies), including without limitation performance bond sureties and payment bond sureties;
- (2) A contracting agency for its procurement costs;
- (3) A trustee(s) (either a court-appointed trustee or a U.S. trustee, or both) in bankruptcy of a contractor, or a contractor's bankruptcy estate;
- (4) A contractor's assignee(s);
- (5) A contractor's successor(s); or
- (6) A claim asserted under the Prompt Payment Act, [31 U.S.C. 3901](#)–3907.

4. Subcontracts. The contractor or subcontractor must insert in any subcontracts the clauses set forth in paragraphs 1. through 5. of this section and a clause requiring the subcontractors to include these clauses in any lower tier subcontracts. The prime contractor is responsible for compliance by any subcontractor or lower tier subcontractor with the clauses set forth in paragraphs 1. through 5. In the

event of any violations of these clauses, the prime contractor and any subcontractor(s) responsible will be liable for any unpaid wages and monetary relief, including interest from the date of the underpayment or loss, due to any workers of lower-tier subcontractors, and associated liquidated damages and may be subject to debarment, as appropriate.

5. Anti-retaliation. It is unlawful for any person to discharge, demote, intimidate, threaten, restrain, coerce, blacklist, harass, or in any other manner discriminate against, or to cause any person to discharge, demote, intimidate, threaten, restrain, coerce, blacklist, harass, or in any other manner discriminate against, any worker or job applicant for:

a. Notifying any contractor of any conduct which the worker reasonably believes constitutes a violation of the Contract Work Hours and Safety Standards Act (CWHSSA) or its implementing regulations in this part;

b. Filing any complaint, initiating or causing to be initiated any proceeding, or otherwise asserting or seeking to assert on behalf of themselves or others any right or protection under CWHSSA or this part;

c. Cooperating in any investigation or other compliance action, or testifying in any proceeding under CWHSSA or this part; or

d. Informing any other person about their rights under CWHSSA or this part.

VI. SUBLETTING OR ASSIGNING THE CONTRACT

This provision is applicable to all Federal-aid construction contracts on the National Highway System pursuant to 23 CFR 635.116.

1. The contractor shall perform with its own organization contract work amounting to not less than 30 percent (or a greater percentage if specified elsewhere in the contract) of the total original contract price, excluding any specialty items designated by the contracting agency. Specialty items may be performed by subcontract and the amount of any such specialty items performed may be deducted from the total original contract price before computing the amount of work required to be performed by the contractor's own organization (23 CFR 635.116).

a. The term "perform work with its own organization" in paragraph 1 of Section VI refers to workers employed or leased by the prime contractor, and equipment owned or rented by the prime contractor, with or without operators. Such term does not include employees or equipment of a subcontractor or lower tier subcontractor, agents of the prime contractor, or any other assignees. The term may include payments for the costs of hiring leased employees from an employee leasing firm meeting all relevant Federal and State regulatory requirements. Leased employees may only be included in this term if the prime contractor meets all of the following conditions: (based on longstanding interpretation)

- (1) the prime contractor maintains control over the supervision of the day-to-day activities of the leased employees;
- (2) the prime contractor remains responsible for the quality of the work of the leased employees;

- (3) the prime contractor retains all power to accept or exclude individual employees from work on the project; and
- (4) the prime contractor remains ultimately responsible for the payment of predetermined minimum wages, the submission of payrolls, statements of compliance and all other Federal regulatory requirements.

b. "Specialty Items" shall be construed to be limited to work that requires highly specialized knowledge, abilities, or equipment not ordinarily available in the type of contracting organizations qualified and expected to bid or propose on the contract as a whole and in general are to be limited to minor components of the overall contract. 23 CFR 635.102.

2. Pursuant to 23 CFR 635.116(a), the contract amount upon which the requirements set forth in paragraph (1) of Section VI is computed includes the cost of material and manufactured products which are to be purchased or produced by the contractor under the contract provisions.

3. Pursuant to 23 CFR 635.116(c), the contractor shall furnish (a) a competent superintendent or supervisor who is employed by the firm, has full authority to direct performance of the work in accordance with the contract requirements, and is in charge of all construction operations (regardless of who performs the work) and (b) such other of its own organizational resources (supervision, management, and engineering services) as the contracting officer determines is necessary to assure the performance of the contract.

4. No portion of the contract shall be sublet, assigned or otherwise disposed of except with the written consent of the contracting officer, or authorized representative, and such consent when given shall not be construed to relieve the contractor of any responsibility for the fulfillment of the contract. Written consent will be given only after the contracting agency has assured that each subcontract is evidenced in writing and that it contains all pertinent provisions and requirements of the prime contract. (based on long-standing interpretation of 23 CFR 635.116).

5. The 30-percent self-performance requirement of paragraph (1) is not applicable to design-build contracts; however, contracting agencies may establish their own self-performance requirements. 23 CFR 635.116(d).

VII. SAFETY: ACCIDENT PREVENTION

This provision is applicable to all Federal-aid construction contracts and to all related subcontracts.

1. In the performance of this contract the contractor shall comply with all applicable Federal, State, and local laws governing safety, health, and sanitation (23 CFR Part 635). The contractor shall provide all safeguards, safety devices and protective equipment and take any other needed actions as it determines, or as the contracting officer may determine, to be reasonably necessary to protect the life and health of employees on the job and the safety of the public and to protect property in connection with the performance of the work covered by the contract. 23 CFR 635.108.

2. It is a condition of this contract, and shall be made a condition of each subcontract, which the contractor enters into pursuant to this contract, that the contractor and any subcontractor shall not permit any employee, in performance of the contract, to work in surroundings or under conditions which are unsanitary, hazardous or dangerous to his/her health or safety, as determined under construction safety and

health standards (29 CFR Part 1926) promulgated by the Secretary of Labor, in accordance with Section 107 of the Contract Work Hours and Safety Standards Act (40 U.S.C. 3704). 29 CFR 1926.10.

3. Pursuant to 29 CFR 1926.3, it is a condition of this contract that the Secretary of Labor or authorized representative thereof, shall have right of entry to any site of contract performance to inspect or investigate the matter of compliance with the construction safety and health standards and to carry out the duties of the Secretary under Section 107 of the Contract Work Hours and Safety Standards Act (40 U.S.C. 3704).

VIII. FALSE STATEMENTS CONCERNING HIGHWAY PROJECTS

This provision is applicable to all Federal-aid construction contracts and to all related subcontracts.

In order to assure high quality and durable construction in conformity with approved plans and specifications and a high degree of reliability on statements and representations made by engineers, contractors, suppliers, and workers on Federal-aid highway projects, it is essential that all persons concerned with the project perform their functions as carefully, thoroughly, and honestly as possible. Willful falsification, distortion, or misrepresentation with respect to any facts related to the project is a violation of Federal law. To prevent any misunderstanding regarding the seriousness of these and similar acts, Form FHWA-1022 shall be posted on each Federal-aid highway project (23 CFR Part 635) in one or more places where it is readily available to all persons concerned with the project:

18 U.S.C. 1020 reads as follows:

"Whoever, being an officer, agent, or employee of the United States, or of any State or Territory, or whoever, whether a person, association, firm, or corporation, knowingly makes any false statement, false representation, or false report as to the character, quality, quantity, or cost of the material used or to be used, or the quantity or quality of the work performed or to be performed, or the cost thereof in connection with the submission of plans, maps, specifications, contracts, or costs of construction on any highway or related project submitted for approval to the Secretary of Transportation; or

Whoever knowingly makes any false statement, false representation, false report or false claim with respect to the character, quality, quantity, or cost of any work performed or to be performed, or materials furnished or to be furnished, in connection with the construction of any highway or related project approved by the Secretary of Transportation; or

Whoever knowingly makes any false statement or false representation as to material fact in any statement, certificate, or report submitted pursuant to provisions of the Federal-aid Roads Act approved July 11, 1916, (39 Stat. 355), as amended and supplemented;

Shall be fined under this title or imprisoned not more than 5 years or both."

IX. IMPLEMENTATION OF CLEAN AIR ACT AND FEDERAL WATER POLLUTION CONTROL ACT (42 U.S.C. 7606; 2 CFR 200.88; EO 11738)

This provision is applicable to all Federal-aid construction contracts in excess of \$150,000 and to all related subcontracts. 48 CFR 2.101; 2 CFR 200.327.

By submission of this bid/proposal or the execution of this contract or subcontract, as appropriate, the bidder, proposer, Federal-aid construction contractor, subcontractor, supplier, or vendor agrees to comply with all applicable standards, orders or regulations issued pursuant to the Clean Air Act (42 U.S.C. 7401-7671q) and the Federal Water Pollution Control Act, as amended (33 U.S.C. 1251-1387). Violations must be reported to the Federal Highway Administration and the Regional Office of the Environmental Protection Agency. 2 CFR Part 200, Appendix II.

The contractor agrees to include or cause to be included the requirements of this Section in every subcontract, and further agrees to take such action as the contracting agency may direct as a means of enforcing such requirements. 2 CFR 200.327.

X. CERTIFICATION REGARDING DEBARMENT, SUSPENSION, INELIGIBILITY AND VOLUNTARY EXCLUSION

This provision is applicable to all Federal-aid construction contracts, design-build contracts, subcontracts, lower-tier subcontracts, purchase orders, lease agreements, consultant contracts or any other covered transaction requiring FHWA approval or that is estimated to cost \$25,000 or more – as defined in 2 CFR Parts 180 and 1200. 2 CFR 180.220 and 1200.220.

1. Instructions for Certification – First Tier Participants:

- a. By signing and submitting this proposal, the prospective first tier participant is providing the certification set out below.
- b. The inability of a person to provide the certification set out below will not necessarily result in denial of participation in this covered transaction. The prospective first tier participant shall submit an explanation of why it cannot provide the certification set out below. The certification or explanation will be considered in connection with the department or agency's determination whether to enter into this transaction. However, failure of the prospective first tier participant to furnish a certification or an explanation shall disqualify such a person from participation in this transaction. 2 CFR 180.320.
- c. The certification in this clause is a material representation of fact upon which reliance was placed when the contracting agency determined to enter into this transaction. If it is later determined that the prospective participant knowingly rendered an erroneous certification, in addition to other remedies available to the Federal Government, the contracting agency may terminate this transaction for cause of default. 2 CFR 180.325.
- d. The prospective first tier participant shall provide immediate written notice to the contracting agency to whom this proposal is submitted if any time the prospective first tier participant learns that its certification was erroneous when submitted or has become erroneous by reason of changed circumstances. 2 CFR 180.345 and 180.350.

e. The terms "covered transaction," "debarred," "suspended," "ineligible," "participant," "person," "principal," and "voluntarily excluded," as used in this clause, are defined in 2 CFR Parts 180, Subpart I, 180.900-180.1020, and 1200. "First Tier Covered Transactions" refers to any covered transaction between a recipient or subrecipient of Federal funds and a participant (such as the prime or general contract). "Lower Tier Covered Transactions" refers to any covered transaction under a First Tier Covered Transaction (such as subcontracts). "First Tier Participant" refers to the participant who has entered into a covered transaction with a recipient or subrecipient of Federal funds (such as the prime or general contractor). "Lower Tier Participant" refers any participant who has entered into a covered transaction with a First Tier Participant or other Lower Tier Participants (such as subcontractors and suppliers).

f. The prospective first tier participant agrees by submitting this proposal that, should the proposed covered transaction be entered into, it shall not knowingly enter into any lower tier covered transaction with a person who is debarred, suspended, declared ineligible, or voluntarily excluded from participation in this covered transaction, unless authorized by the department or agency entering into this transaction. 2 CFR 180.330.

g. The prospective first tier participant further agrees by submitting this proposal that it will include the clause titled "Certification Regarding Debarment, Suspension, Ineligibility and Voluntary Exclusion-Lower Tier Covered Transactions," provided by the department or contracting agency, entering into this covered transaction, without modification, in all lower tier covered transactions and in all solicitations for lower tier covered transactions exceeding the \$25,000 threshold. 2 CFR 180.220 and 180.300.

h. A participant in a covered transaction may rely upon a certification of a prospective participant in a lower tier covered transaction that is not debarred, suspended, ineligible, or voluntarily excluded from the covered transaction, unless it knows that the certification is erroneous. 2 CFR 180.300; 180.320, and 180.325. A participant is responsible for ensuring that its principals are not suspended, debarred, or otherwise ineligible to participate in covered transactions. 2 CFR 180.335. To verify the eligibility of its principals, as well as the eligibility of any lower tier prospective participants, each participant may, but is not required to, check the System for Award Management website (<https://www.sam.gov/>). 2 CFR 180.300, 180.320, and 180.325.

i. Nothing contained in the foregoing shall be construed to require the establishment of a system of records in order to render in good faith the certification required by this clause. The knowledge and information of the prospective participant is not required to exceed that which is normally possessed by a prudent person in the ordinary course of business dealings.

j. Except for transactions authorized under paragraph (f) of these instructions, if a participant in a covered transaction knowingly enters into a lower tier covered transaction with a person who is suspended, debarred, ineligible, or voluntarily excluded from participation in this transaction, in addition to other remedies available to the Federal Government, the department or agency may terminate this transaction for cause or default. 2 CFR 180.325.

* * * * *

2. Certification Regarding Debarment, Suspension, Ineligibility and Voluntary Exclusion – First Tier Participants:

a. The prospective first tier participant certifies to the best of its knowledge and belief, that it and its principals:

(1) Are not presently debarred, suspended, proposed for debarment, declared ineligible, or voluntarily excluded from participating in covered transactions by any Federal department or agency, 2 CFR 180.335;

(2) Have not within a three-year period preceding this proposal been convicted of or had a civil judgment rendered against them for commission of fraud or a criminal offense in connection with obtaining, attempting to obtain, or performing a public (Federal, State, or local) transaction or contract under a public transaction; violation of Federal or State antitrust statutes or commission of embezzlement, theft, forgery, bribery, falsification or destruction of records, making false statements, or receiving stolen property, 2 CFR 180.800;

(3) Are not presently indicted for or otherwise criminally or civilly charged by a governmental entity (Federal, State or local) with commission of any of the offenses enumerated in paragraph (a)(2) of this certification, 2 CFR 180.700 and 180.800; and

(4) Have not within a three-year period preceding this application/proposal had one or more public transactions (Federal, State or local) terminated for cause or default. 2 CFR 180.335(d).

(5) Are not a corporation that has been convicted of a felony violation under any Federal law within the two-year period preceding this proposal (USDOT Order 4200.6 implementing appropriations act requirements); and

(6) Are not a corporation with any unpaid Federal tax liability that has been assessed, for which all judicial and administrative remedies have been exhausted, or have lapsed, and that is not being paid in a timely manner pursuant to an agreement with the authority responsible for collecting the tax liability (USDOT Order 4200.6 implementing appropriations act requirements).

b. Where the prospective participant is unable to certify to any of the statements in this certification, such prospective participant should attach an explanation to this proposal. 2 CFR 180.335 and 180.340.

3. Instructions for Certification - Lower Tier Participants:

(Applicable to all subcontracts, purchase orders, and other lower tier transactions requiring prior FHWA approval or estimated to cost \$25,000 or more - 2 CFR Parts 180 and 1200). 2 CFR 180.220 and 1200.220.

a. By signing and submitting this proposal, the prospective lower tier participant is providing the certification set out below.

b. The certification in this clause is a material representation of fact upon which reliance was placed when this transaction was entered into. If it is later determined that the prospective lower tier participant knowingly rendered an erroneous certification, in addition to other remedies available to the Federal Government, the department, or agency with which

this transaction originated may pursue available remedies, including suspension and/or debarment.

c. The prospective lower tier participant shall provide immediate written notice to the person to which this proposal is submitted if at any time the prospective lower tier participant learns that its certification was erroneous by reason of changed circumstances. 2 CFR 180.365.

d. The terms "covered transaction," "debarred," "suspended," "ineligible," "participant," "person," "principal," and "voluntarily excluded," as used in this clause, are defined in 2 CFR Parts 180, Subpart I, 180.900 – 180.1020, and 1200. You may contact the person to which this proposal is submitted for assistance in obtaining a copy of those regulations. "First Tier Covered Transactions" refers to any covered transaction between a recipient or subrecipient of Federal funds and a participant (such as the prime or general contract). "Lower Tier Covered Transactions" refers to any covered transaction under a First Tier Covered Transaction (such as subcontracts). "First Tier Participant" refers to the participant who has entered into a covered transaction with a recipient or subrecipient of Federal funds (such as the prime or general contractor). "Lower Tier Participant" refers any participant who has entered into a covered transaction with a First Tier Participant or other Lower Tier Participants (such as subcontractors and suppliers).

e. The prospective lower tier participant agrees by submitting this proposal that, should the proposed covered transaction be entered into, it shall not knowingly enter into any lower tier covered transaction with a person who is debarred, suspended, declared ineligible, or voluntarily excluded from participation in this covered transaction, unless authorized by the department or agency with which this transaction originated. 2 CFR 1200.220 and 1200.332.

f. The prospective lower tier participant further agrees by submitting this proposal that it will include this clause titled "Certification Regarding Debarment, Suspension, Ineligibility and Voluntary Exclusion-Lower Tier Covered Transaction," without modification, in all lower tier covered transactions and in all solicitations for lower tier covered transactions exceeding the \$25,000 threshold. 2 CFR 180.220 and 1200.220.

g. A participant in a covered transaction may rely upon a certification of a prospective participant in a lower tier covered transaction that is not debarred, suspended, ineligible, or voluntarily excluded from the covered transaction, unless it knows that the certification is erroneous. A participant is responsible for ensuring that its principals are not suspended, debarred, or otherwise ineligible to participate in covered transactions. To verify the eligibility of its principals, as well as the eligibility of any lower tier prospective participants, each participant may, but is not required to, check the System for Award Management website (<https://www.sam.gov/>), which is compiled by the General Services Administration. 2 CFR 180.300, 180.320, 180.330, and 180.335.

h. Nothing contained in the foregoing shall be construed to require establishment of a system of records in order to render in good faith the certification required by this clause. The knowledge and information of participant is not required to exceed that which is normally possessed by a prudent person in the ordinary course of business dealings.

i. Except for transactions authorized under paragraph e of these instructions, if a participant in a covered transaction knowingly enters into a lower tier covered transaction with a person who is suspended, debarred, ineligible, or voluntarily

excluded from participation in this transaction, in addition to other remedies available to the Federal Government, the department or agency with which this transaction originated may pursue available remedies, including suspension and/or debarment. 2 CFR 180.325.

* * * * *

4. Certification Regarding Debarment, Suspension, Ineligibility and Voluntary Exclusion--Lower Tier Participants:

a. The prospective lower tier participant certifies, by submission of this proposal, that neither it nor its principals:

(1) is presently debarred, suspended, proposed for debarment, declared ineligible, or voluntarily excluded from participating in covered transactions by any Federal department or agency, 2 CFR 180.355;

(2) is a corporation that has been convicted of a felony violation under any Federal law within the two-year period preceding this proposal (USDOT Order 4200.6 implementing appropriations act requirements); and

(3) is a corporation with any unpaid Federal tax liability that has been assessed, for which all judicial and administrative remedies have been exhausted, or have lapsed, and that is not being paid in a timely manner pursuant to an agreement with the authority responsible for collecting the tax liability. (USDOT Order 4200.6 implementing appropriations act requirements)

b. Where the prospective lower tier participant is unable to certify to any of the statements in this certification, such prospective participant should attach an explanation to this proposal.

* * * * *

XI. CERTIFICATION REGARDING USE OF CONTRACT FUNDS FOR LOBBYING

This provision is applicable to all Federal-aid construction contracts and to all related subcontracts which exceed \$100,000. 49 CFR Part 20, App. A.

1. The prospective participant certifies, by signing and submitting this bid or proposal, to the best of his or her knowledge and belief, that:

a. No Federal appropriated funds have been paid or will be paid, by or on behalf of the undersigned, to any person for influencing or attempting to influence an officer or employee of any Federal agency, a Member of Congress, an officer or employee of Congress, or an employee of a Member of Congress in connection with the awarding of any Federal contract, the making of any Federal grant, the making of any Federal loan, the entering into of any cooperative agreement, and the extension, continuation, renewal, amendment, or modification of any Federal contract, grant, loan, or cooperative agreement.

b. If any funds other than Federal appropriated funds have been paid or will be paid to any person for influencing or attempting to influence an officer or employee of any Federal agency, a Member of Congress, an officer or employee of Congress, or an employee of a Member of Congress in connection with this Federal contract, grant, loan, or

cooperative agreement, the undersigned shall complete and submit Standard Form-LLL, "Disclosure Form to Report Lobbying," in accordance with its instructions.

2. This certification is a material representation of fact upon which reliance was placed when this transaction was made or entered into. Submission of this certification is a prerequisite for making or entering into this transaction imposed by 31 U.S.C. 1352. Any person who fails to file the required certification shall be subject to a civil penalty of not less than \$10,000 and not more than \$100,000 for each such failure.

3. The prospective participant also agrees by submitting its bid or proposal that the participant shall require that the language of this certification be included in all lower tier subcontracts, which exceed \$100,000 and that all such recipients shall certify and disclose accordingly.

XII. USE OF UNITED STATES-FLAG VESSELS:

This provision is applicable to all Federal-aid construction contracts, design-build contracts, subcontracts, lower-tier subcontracts, purchase orders, lease agreements, or any other covered transaction. 46 CFR Part 381.

This requirement applies to material or equipment that is acquired for a specific Federal-aid highway project. 46 CFR 381.7. It is not applicable to goods or materials that come into inventories independent of an FHWA funded-contract.

When oceanic shipments (or shipments across the Great Lakes) are necessary for materials or equipment acquired for a specific Federal-aid construction project, the bidder, proposer, contractor, subcontractor, or vendor agrees:

1. To utilize privately owned United States-flag commercial vessels to ship at least 50 percent of the gross tonnage (computed separately for dry bulk carriers, dry cargo liners, and tankers) involved, whenever shipping any equipment, material, or commodities pursuant to this contract, to the extent such vessels are available at fair and reasonable rates for United States-flag commercial vessels. 46 CFR 381.7.

2. To furnish within 20 days following the date of loading for shipments originating within the United States or within 30 working days following the date of loading for shipments originating outside the United States, a legible copy of a rated, 'on-board' commercial ocean bill-of-lading in English for each shipment of cargo described in paragraph (b)(1) of this section to both the Contracting Officer (through the prime contractor in the case of subcontractor bills-of-lading) and to the Office of Cargo and Commercial Sealift (MAR-620), Maritime Administration, Washington, DC 20590. (MARAD requires copies of the ocean carrier's (master) bills of lading, certified onboard, dated, with rates and charges. These bills of lading may contain business sensitive information and therefore may be submitted directly to MARAD by the Ocean Transportation Intermediary on behalf of the contractor). 46 CFR 381.7.

**ATTACHMENT A - EMPLOYMENT AND MATERIALS
PREFERENCE FOR APPALACHIAN DEVELOPMENT
HIGHWAY SYSTEM OR APPALACHIAN LOCAL ACCESS
ROAD CONTRACTS (23 CFR 633, Subpart B, Appendix B)**

This provision is applicable to all Federal-aid projects funded under the Appalachian Regional Development Act of 1965.

1. During the performance of this contract, the contractor undertaking to do work which is, or reasonably may be, done as on-site work, shall give preference to qualified persons who regularly reside in the labor area as designated by the DOL wherein the contract work is situated, or the subregion, or the Appalachian counties of the State wherein the contract work is situated, except:

a. To the extent that qualified persons regularly residing in the area are not available.

b. For the reasonable needs of the contractor to employ supervisory or specially experienced personnel necessary to assure an efficient execution of the contract work.

c. For the obligation of the contractor to offer employment to present or former employees as the result of a lawful collective bargaining contract, provided that the number of nonresident persons employed under this subparagraph (1c) shall not exceed 20 percent of the total number of employees employed by the contractor on the contract work, except as provided in subparagraph (4) below.

2. The contractor shall place a job order with the State Employment Service indicating (a) the classifications of the laborers, mechanics and other employees required to perform the contract work, (b) the number of employees required in each classification, (c) the date on which the participant estimates such employees will be required, and (d) any other pertinent information required by the State Employment Service to complete the job order form. The job order may be placed with the State Employment Service in writing or by telephone. If during the course of the contract work, the information submitted by the contractor in the original job order is substantially modified, the participant shall promptly notify the State Employment Service.

3. The contractor shall give full consideration to all qualified job applicants referred to him by the State Employment Service. The contractor is not required to grant employment to any job applicants who, in his opinion, are not qualified to perform the classification of work required.

4. If, within one week following the placing of a job order by the contractor with the State Employment Service, the State Employment Service is unable to refer any qualified job applicants to the contractor, or less than the number requested, the State Employment Service will forward a certificate to the contractor indicating the unavailability of applicants. Such certificate shall be made a part of the contractor's permanent project records. Upon receipt of this certificate, the contractor may employ persons who do not normally reside in the labor area to fill positions covered by the certificate, notwithstanding the provisions of subparagraph (1c) above.

5. The provisions of 23 CFR 633.207(e) allow the contracting agency to provide a contractual preference for the use of mineral resource materials native to the Appalachian region.

6. The contractor shall include the provisions of Sections 1 through 4 of this Attachment A in every subcontract for work which is, or reasonably may be, done as on-site work.

MISSOURI DEPARTMENT OF NATURAL RESOURCES
Federal Financial Assistance Agreements
General Terms and Conditions

These general terms and conditions highlight requirements which are especially pertinent to federal assistance agreements made by the Missouri Department of Natural Resources. These general terms and conditions do not set out all of the provisions of the applicable laws and regulations, nor do they represent an exhaustive list of all requirements applicable to this award. These terms and conditions are emphasized here because they are frequently invoked and their violation is of serious concern.

Pursuant to 2 CFR 200.331, the sub-recipient shall require the language of the certifications and terms applicable to financial assistance awards to be included in sub-award document at all tiers and all sub-recipients shall certify and disclose accordingly. This “flow down” requirement imposed on the sponsoring agent by the Department is to ensure the financial assistance agreement is used in accordance with Federal statutes, regulations and the terms of the agreement. The sponsoring agent is accountable to the Department for compliance with Federal requirements. In turn, the Department is responsible to federal agency for ensuring sponsoring agents comply with Federal requirements and with federal General Terms and Conditions:

In addition to these terms and conditions, the recipient must comply with all governing requirements of their financial assistance agreement, including the Title 2 Grants and Agreements, Chapter II Part 200 of the Code of Federal Regulation, under the title "Uniform Administrative Requirements, Cost Principles, and Audit Requirements for Federal Awards." The regulations can be found at http://www.ecfr.gov/cgi-bin/text-idx?SID=da74e925e27b89e7f8625019850377cf&tpl=/ecfrbrowse/Title02/2tab_02.tpl.

I. Administrative Requirements

- A. **Method of Payment.** The recipient will be reimbursed by the Department for all allowable expenses incurred in performing the scope of services. The recipient shall report project expenses and submit to the Department original payment requests as required by division/program per the financial assistance agreement. The form must be completed with the Department payment request amount and local share detailed, if applicable. Payment requests must provide a breakdown of project expenses by the budget categories contained in the financial assistance agreement budget. Payment requests must be received by the Department per the financial assistance agreement. No reimbursement will be made for expenditures prior to award unless approval for pre-award costs has been granted. No reimbursements will be made for expenditures incurred after the closing budget date unless a budget time period extension has been granted by the Department prior to the closing budget date.
1. Payments under non-construction grants will be based on the grant sharing ratio as applied to the total agreed project cost for each invoice submitted unless the financial assistance agreement specifically provides for advance

payments. Advance payments may only be made upon a showing of good cause or special circumstances, as determined by the Department and must be as close as is administratively feasible to the actual disbursement. Advance payments will only be made to cover estimated expenditures as agreed. The Department will not advance more than 25% of the total amount of the grant unless the recipient demonstrates good cause.

2. All payment requests must have the following certification by the authorized recipient official: By signing this report, I certify to the best of my knowledge and belief the report is true, complete and accurate and the expenditures, disbursements and cash receipts are for the purposes and objectives set forth in the terms and conditions of the financial assistance agreement. I am aware that any false, fictitious, or fraudulent information, or the omission of any material fact, may subject me to criminal, civil or administrative penalties for fraud, false statements, false claims or otherwise.

B. Retention and Custodial Requirements for Records. The recipient shall retain financial records, supporting documents, statistical records and all other records pertinent to the financial assistance agreement for a period of five years starting from the date of submission of the final payment request. Authorized representatives of federal awarding agencies, the Federal Inspectors General, the Comptroller General of the United States, the State Auditor's Office, the Department or any of their designees shall have access to any pertinent books, documents, and records of recipient in order to conduct audits or examinations. The recipient agrees to allow monitoring and auditing by the Department and/or authorized representative. If any litigation, claim, negotiation, audit, or other action involving the records has been started before the expiration of the five year period, the recipient shall retain records until all litigations, claims or audit findings involving the records have been resolved and final action taken.

C. Program Income.

1. The recipient is encouraged to earn income to defray program costs. Program income means gross income earned that is directly generated by a supported activity or earned as a result of the financial assistance agreement during the period of performance. Program income includes but is not limited to income from: fees for services performed, the use or rental of real or personal property acquired with financial assistance funds, the sale of commodities or items fabricated under the financial assistance agreement, license fees and royalties on patents and copyrights and payments of principal and interest on loans made with financial assistance funds. Program income does not include items such as rebates, credits, discounts, or refunds and interest earned.

2. Program income shall be deducted from total allowable outlays to determine net allowable costs. With prior approval of the federal awarding agency, program income may be added to the federal award or used to meet cost sharing or matching requirements. The default deductive alternative requires that program income be deducted from total allowable costs to determine the net allowable amount to which the respective matching ratios are applied. For example, 50/50 share ratio agreement with total allowable costs of \$10,000 that earns \$1,000 in program income would result in \$4,500 net share and a \$4,500 net financial assistance share.

D. **Match or Cost Share Funding.** In general, match or cost sharing represents that portion of project costs not borne by state appropriations. The matching share will usually be prescribed as a minimum percentage. In-kind (noncash) contributions are allowable project costs when they directly benefit and are necessary and reasonable for the accomplishment of the project or program objectives. Any in-kind match must be assigned a fair market value consistent with those paid for similar work in the labor market and be documented and verifiable. Neither costs nor the values of third party in-kind contributions count towards satisfying a cost sharing or matching requirement of a grant agreement if they have been or will be counted towards satisfying a cost sharing or matching requirement of another federal financial assistance agreement, a federal procurement contract, or any other award of federal funds. Federal funds from another federal grant or financial assistance agreement shall not count towards satisfying a cost sharing or matching requirement of a grant agreement.

1. Match or cost share funding will be established by the Department through negotiation with the recipient. Signature by both the Department and recipient on the financial assistance agreement form firmly affixes the match or cost sharing ratios. Full expenditure of recipient match or cost share funding is required over the life of the financial assistance agreement. Recipient must submit payment requests to the Department, as required by the financial assistance agreement, and provide financial records for total expenditure of state and match or cost share funding. The Department will reimburse the recipient for its percentage portion agreed to less any negotiated withholding.
2. Failure to provide 100% of the match or cost share ratio of total expenditures as identified in the financial assistance agreement may cause the recipient to become ineligible to receive additional financial assistance from the Department. Failure to provide the required match may result in other enforcement remedies as stated in Y. for noncompliance.

E. **Financial Management Systems.** The financial management systems of the recipient must meet the following standards:

1. **Financial Reporting.** Accurate, current, and complete disclosure of financial results of financially assisted activities must be made in accordance with the financial reporting requirements of the financial assistance agreement;
2. **Accounting Records.** Maintain records which adequately identify the source and application of funds provided for financially assisted activities to include the CFDA title and number, Federal Award Identification Number (FAIN) and year, name of the federal agency and pass-thru entity. These records must contain information pertaining to financial assistance awards and authorizations, obligations, unobligated balances, assets, liabilities, outlays or expenditures, and income;
3. **Internal Control.** Effective written internal controls and accountability must be maintained for all recipient cash, real and personal property, and other assets. The recipient must adequately safeguard all such property and must assure that it is used solely for authorized purposes. These internal controls should be in compliance with guidance in the “Standards for Internal Control in the Federal Government” and the “Internal Control Integrated Framework”;
4. **Budget Control.** Actual expenditures or outlays must be compared with budgeted amounts for each financial assistance agreement;
5. **Allowable Costs.** OMB cost principles, applicable federal agency program regulations, and the financial assistance agreement scope of work will be followed in determining the reasonableness, allowability and allocability of costs;
6. **Source Documentation.** Records must adequately identify the source and application of funds for federally funded activities. These records must contain information pertaining to Federal awards, authorizations, obligations, unobligated balances, assets, expenditures, income and interest and be supported by source documentation. The documentation must be made available by the recipient at the Department’s request or any of the following: authorized representatives of the federal awarding agency, the Federal Inspector General, the Comptroller General of the United States, State Auditor’s Office or any of their designees;
7. The recipient shall have written procedures in place to minimize the time lapsed between money disbursed by the Department and spent by the recipient.

- F. **Reporting of Program Performance.** The recipient shall submit to the Department a performance report for each program, function, or activity as specified by the financial assistance agreement or at least annually and/or after completion of the project. Performance report requirements, if not expressly stated in the scope of work, should include, at a minimum, a comparison of actual accomplishments to the goals established, reasons why goals were not met, including analysis and explanation of cost overruns or higher unit cost when appropriate, and other pertinent information. Representatives of the Department, the federal awarding agency, the Federal Inspector General, the Comptroller General of the United States, State Auditor's Office or any of their designees shall have the right to visit the project site(s) during reasonable hours for the duration of the contract period and for five years thereafter.
- G. **Budget and Scope of Work Revisions.** The recipient is permitted to rebudget within the approved direct cost budget to meet unanticipated requirements. The following is a non-exclusive listing of when a recipient must request approval in writing to revise budgets and scopes of work under the following conditions:
1. For non-construction grants, the recipient shall obtain the prior approval of the Department, unless waived by the Department, for cumulative transfers among direct cost categories, or, if applicable, among separately budgeted programs, projects, functions or activities when the accumulative amounts of such transfers exceed or are expected to exceed 10% of the current total approved budget whenever the Department's share exceeds the simplified acquisition amount threshold.
 2. For construction and non-construction projects, the recipient shall obtain prior written approval from the Department for any budget revision which would result in the need for additional funds.
 3. For combined non-construction and construction projects, the recipient must obtain prior written approval from the Department before making any fund or budget transfer from the non-construction to construction or vice versa.
 4. A recipient under non-construction projects must obtain prior written approval from the Department whenever contracting out, subgranting, or otherwise obtaining a third party to perform activities which are central to the purpose of the award.
 5. Changes to the scope of services, including changes to key personnel described in the financial assistance agreement, must receive prior approval from the Department. Approved changes in the scope of work or budget shall be incorporated by written amendment to the financial assistance agreement.

6. The disengagement from the project for more than three months, or a 25 percent reduction in time devoted to the project, by the approved project director or principal investigator.
7. Changes in the amount of approved cost-sharing or matching provided by the recipient. No other prior approval requirements for specific items may be imposed unless a deviation has been approved.
8. Initiate a one-time extension of the period of performance by up to 12 months unless one or more of the conditions outlined below apply. For one-time extensions, the recipient must notify the Department in writing with the supporting reasons and revised period of performance at least 90 calendar days before the end of the period of performance specified in the financial assistance agreement. This one-time extension may not be exercised merely for the purpose of using unobligated balances. Extensions require explicit prior approval from Department when:
 - a. The terms and conditions of the financial assistance agreement prohibit the extension.
 - b. The extension requires additional funds.
 - c. The extension involves any change in the approved objectives or scope of the project.
 - d. Carry forward unobligated balances to subsequent period of performance.
9. Extending the agreement past the original completion date requires approval of the Department.

H. **Equipment Use.** The recipient agrees that any equipment purchased pursuant to this agreement shall be used for the performance of services under this agreement during the term of this agreement. The recipient may not use equipment purchased pursuant to this agreement for any other purpose without approval from the Department. The equipment shall not be moved from the State of Missouri without approval from the Department. State agencies shall follow the Code of State Regulations. The following standards shall govern the utilization and disposition of equipment acquired with financial assistance funds:

1. Title to equipment acquired under this financial assistance agreement will vest with the recipient on acquisition. Equipment means an article of nonexpendable, tangible personal property (including information technology systems) having a useful life of more than one year and a per unit acquisition cost which equals or exceed the lesser of the capitalization level established by the recipient for financial statement purposes or \$5,000.

- a. Equipment shall be used by the recipient in the program or project for which it was acquired as long as needed, whether or not the project or program continues to be supported by Department funds. When no longer needed for the original program or project, the equipment may be used in other activities currently or previously supported by the Department or the federal agency. If the Department puts the recipient on notice that it believes assistance assets are not being used for the intended purpose, the recipient shall not sell, give away, move or abandon the assets without the Department's prior written approval.
 - b. The recipient shall also make equipment available for use on other projects or programs currently or previously supported by the Department, providing such use will not interfere with the work on the projects or program for which it was originally acquired. User fees should be considered if appropriate.
 - c. The recipient must not use equipment acquired with funding from this financial assistance agreement to provide services for a fee to compete unfairly with private companies that provide equivalent services, unless specifically permitted or contemplated by state or federal law. This fee may be considered program income under Section C, Program Income.
 - d. When acquiring replacement equipment, the recipient may use the equipment to be replaced as a trade-in or sell the property and use the proceeds to offset the cost of the replacement property, subject to the approval of the Department.
2. Equipment Management. The recipient's procedures for managing equipment, whether acquired in whole or in part with financial assistance funds, will, at a minimum, meet the following requirements until disposition takes place:
- a. The recipient must maintain property records that include a description of the equipment, a serial number or other identification number, the source of funding, the acquisition date, cost of the property, percentage of federal or state participation in the cost of the property, the location, use and condition of the property and disposition information including the date of the disposal and sale price of the property.
 - b. A physical inventory of the property must be taken and the results reconciled with the property records at least once every two years.

- c. A control system must be developed to ensure adequate safeguards to prevent against loss, damage, or theft of the property. Any loss, damage, or theft shall be reported to and investigated by local authorities. The recipient shall procure and maintain insurance covering loss or damage to equipment purchased with a financial assistance agreement, with financially sound and reputable insurance companies or through self-insurance. Amounts and coverage of such risks should be that which are usually carried by companies engaged in the same or similar business and similarly situated.
 - d. The recipient must develop adequate maintenance procedures to keep the property in good condition.
 - e. If the recipient is authorized or required to sell the property, proper sales procedures must be established to ensure the highest possible return.
- 3. Disposition. When original or replacement equipment acquired under the financial assistance agreement is no longer needed for the original project or program or for other activities currently or previously supported by the Department, the recipient shall dispose of the equipment as follows:
 - a. Items of equipment with a current per-unit fair market value \$5,000 or less may be retained, sold or otherwise disposed of with no further obligation to the Department.
 - b. For items of equipment with a current per unit fair market value of more than \$5,000, the Department shall have a right to an amount calculated by multiplying the current market value or proceeds from sale by the Department's share of the equipment. Disposition instructions must be requested from the Department when equipment is no longer needed.
 - c. In cases where a recipient fails to take appropriate disposition actions, the Department may direct the recipient how to dispose of the equipment.
 - d. If the Department puts the recipient on notice that it believes assistance assets are not being used for the intended purpose, the recipient shall not sell, give away, move or abandon the asset without Department's written approval.
- I. **Supplies.** The recipient agrees that all supplies purchased pursuant to this agreement shall be used for the performance of services under this agreement during the term of this agreement. Title to supplies acquired under a financial assistance agreement will

vest, upon acquisitions, with the recipient. If there is a residual inventory of unused supplies exceeding \$5,000 in total aggregate fair market value upon termination or completion of the award, and if the supplies are not needed for any other federally sponsored programs or projects, the recipient shall compensate the department for its share. The recipient must not use supplies acquired with funding from this financial assistance agreement to provide services for a fee to compete unfairly with private companies that provide equivalent services, unless specifically permitted or contemplated by state or federal law. This fee may be considered program income under Section C, Program Income.

- J. **Inventions and Patents.** If any recipient produces subject matter, which is or may be patentable in the course of work sponsored by this financial assistance agreement, the recipient shall promptly and fully disclose such subject matter in writing to the Department. In the event that the recipient fails or declines to file Letters of Patent or to recognize patentable subject matter, the Department reserves the right to file the same. The Department grants to the recipient the opportunity to acquire an exclusive license, including the right to sublicense, with a royalty consideration paid to the Department. Payment of royalties by recipient to the Department will be addressed in a separate royalty agreement.
- K. **Copyrights.** Except as otherwise provided in the terms and conditions of this financial assistance agreement, the author or the recipient is free to copyright any books, publications, or other copyrightable material developed in the course of this agreement. However, the Department and federal awarding agency reserve a royalty-free, nonexclusive and irrevocable right to reproduce, publish, or otherwise use, and to authorize others to use, with the approval of the Department, the work for government purposes.
- L. **Prior Approval for Publications.** The recipient shall submit to the Department two draft copies of each publication and other printed materials which are intended for distribution and are financed, wholly or in part, by financial assistance funds. The recipient shall not print or distribute any publication until receiving written approval by the Department.
- M. **Mandatory Disclosures.** The recipient agrees that all statements, press releases, requests for proposals, bid solicitations, and other documents describing the program/project for which funds are now being awarded will include a statement of the percentage of the total cost of the program/project which is financed with federal and state money, and the dollar amount of federal and state funds for the program/project.
- N. **Procurement Standards.** The recipient shall use their own documented procurement procedures that reflect applicable state and local laws and regulations provided that procurement conforms to standards set forth in the "Uniform Administrative Requirements, Cost Principles and Audit Requirements for Federal Awards."

1. No work or services paid for wholly or in part with state or federal funds, will be contracted without the written consent of the Department.
 2. The recipient agrees that any contract, interagency agreement, or equipment to be procured under this award which was not included in the approved work plan must receive formal Department approval prior to expenditure of funds associated with that contract, interagency agreement, or equipment purchase.
- O. **Audit Requirements.** The Department and the State Auditor's Office have the right to conduct audits of recipients at any time. The recipient shall arrange for independent audits as prescribed in "Uniform Administrative Requirements, Cost Principles and Audit Requirements for Federal Awards, Subpart F", as applicable. Audits must confirm that records accurately reflect the operations of the recipient; the internal control structure provides reasonable assurance that assets are safeguarded, and recipient is in compliance with applicable laws and regulations. When the recipient has its yearly audit conducted by a governmental agency or private auditing firm, the relevant portion(s) of the audit report will be submitted to the Department. Other portions of the audit shall be made available at the Department's request.
- P. **Freedom of Information Act.** In response to a Freedom of Information Act (FOIA) request for research data relating to published research findings produced under a Federal award that were used by the Federal government in developing an agency action that has the force and effect of law, the Department must request, and the recipient must provide, within a reasonable time, the research data so that they can be made available to the public through the procedures established under the FOIA. If the Department obtains the research data solely in response to a FOIA request, the Department may charge the requester a reasonable fee equaling the full incremental cost of obtaining the research data. This fee should reflect costs incurred by the Department and the recipient. This fee is in addition to any fees the Federal awarding agency may assess under the FOIA (5 U.S.C. 552(a)(4)(A)).
- Q. **Conflicts of Interest.** The recipients must have written standards and policies covering conflicts of interest. No party to this financial assistance agreement, nor any officer, agent, or employee of either party to this assistance agreement, shall participate in any decision related to such assistance agreement which could result in a real or apparent conflict of interest, including any decision which would affect their personal or pecuniary interest, directly or indirectly. The recipient is advised that, consistent with Chapter 105, RSMo, no state employee shall perform any service for consideration paid by the recipient for one year after termination of the employee's state employment by which the former state employee attempts to influence a decision of a state agency. A state employee who leaves state employment is permanently banned from performing any service for any consideration in relation to any case, decision, proceeding, or application in which the employee personally participated during state employment.

- R. **State Appropriated Funding.** The recipient agrees that funds expended for the purposes of this financial assistance agreement must be appropriated and made available by the Missouri General Assembly for each fiscal year included within the financial assistance agreement period, as well as being awarded by the federal or state agency supporting the project. Therefore, the financial assistance agreement shall automatically terminate without penalty or termination costs if such funds are not appropriated and/or granted. In the event that funds are not appropriated and/or granted for the financial assistance agreement, the recipient shall not prohibit or otherwise limit the Department's right to pursue alternate solutions and remedies as deemed necessary for the conduct of state government affairs. The requirements stated in this paragraph shall apply to any amendment or the execution of any option to extend the financial assistance agreement.
- S. **Eligibility, Debarment and Suspension (SubPart C).** By applying for this financial assistance agreement, the recipient verifies that it, its board of directors, and all of its principals are currently in compliance with all state and federal environmental laws and court orders issued pursuant to those laws, and that all environmental violations have been resolved (for example, no pending or unresolved Notice of Violation (NOV)) at the time of application. If compliance issues exist, the recipient shall disclose to the Department all pending or unresolved violations noted in a NOV, administrative order, or civil and criminal lawsuit, but only where those alleged violations occurred in the State of Missouri. If a NOV occurs during the financial assistance period, the recipient must notify the Department immediately. The Department will not make any award or payment at any time to any party which is debarred or suspended, under federal or state authority, or is otherwise excluded from or ineligible for participation in federal assistance under Executive Order 12549, "Debarment and Suspension." The recipient may access the Excluded Parties List at www.sam.gov.
- T. **Restrictions on Lobbying.** No portion of this agreement may be expended by the recipient to pay any person for influencing or attempting to influence the executive or legislative branch with respect to the following actions: awarding of a contract; making of an assistance agreement; making of a loan; entering into a cooperative agreement; or the extension, continuation, renewal, amendment or modification of any of these as prohibited by Section 319, Public Law 101-121 (31 U.S.C. 1352).

In accordance with the Byrd Anti-Lobbying Amendment, any recipient who makes a prohibited expenditure under Title 40 CFR Part 34 or fails to file the required certification or lobbying forms shall be subject to a civil penalty of not less than \$10,000 and not more than \$100,000 for each such expenditure.

- U. **Recycled Paper.** Consistent with Federal Executive Order 13423 and EPA Executive Order 1000.25, the recipient shall use recycled paper consisting of at least 30% post-consumer fiber and double sided printing for all reports which are prepared as a part of this assistance agreement and delivered to the Department. The recipient must use

recycled paper for any materials that it produces and makes available to any parties. The chasing arrows symbol representing the recycled content of the paper will be clearly displayed on at least one page of any materials provided to any parties.

V. Contracting with Small and Minority Firms, Women's Business Enterprise, and Labor Surplus Area Firms. In accordance with Missouri Executive Order No. 15-06 and federal administrative provisions, all recipients shall make every feasible effort to target the percentage of goods and services procured from certified minority business enterprises (MBE) and women business enterprises (WBE) to 10% and 10%, respectively, when utilizing financial assistance funds to purchase supplies, equipment, construction and services related to this financial assistance agreement.

1. The recipient agrees to take all necessary affirmative steps required to assure that small and minority firms and women's business enterprises are used when possible as sources when procuring supplies, equipment, construction and services related to the financial assistance agreement. The recipient agrees to include information about these requirements in solicitation documents. Affirmative steps shall include:
 - a. Placing qualified small and minority business and women's business enterprises on solicitation lists;
 - b. Ensuring that small and minority business and women's business enterprises are solicited whenever they are potential sources;
 - c. Dividing total requirements, when economically feasible, into small tasks or quantities to permit maximum participation by small and minority business and women's business enterprises;
 - d. Establishing delivery schedules, where the requirements of work will encourage participation by small and minority business and women's business enterprises;
 - e. Using the services of the Small Business Administration, the Minority Business Development Agency of the U.S. Department of Commerce and the MO Office of Equal Opportunity, and;
 - f. Requiring any prime contractor or other subrecipients, if subagreements are to be allowed, to take the affirmative steps in subparagraphs a. through e. of this section.
2. For EPA funded financial assistance agreements, the recipient agrees to include disadvantaged business enterprises in the affirmative steps indicated above. For EPA funded financial assistance agreements, when

required the recipient shall utilize EPA form 5700-52A to report to Department procurements under the financial assistance agreement.

W. **Disputes.** The recipient and the Department should attempt to resolve disagreements concerning the administration or performance of the financial assistance agreement. If an agreement cannot be reached, the Department will provide a written decision. Such decision of the Department shall be final unless a request for review is submitted to the division director within ten (10) business days after the decision. Such request shall include: (1) a copy of the Department's final decision; (2) a statement of the amount in dispute; (3) a brief description of the issue(s) involved; and (4) a concise statement of the objections to the final decision. A decision by the Department shall constitute final action.

X. **Termination**

1. **Termination for Cause.** The Department may terminate any financial assistance agreement, in whole or in part, at any time before the date of completion whenever it is determined that the recipient has failed to comply with the terms and conditions of the financial assistance agreement. The Department shall promptly notify the recipient in writing of such a determination and the reasons for the termination, together with the effective date. The Department reserves the right to withhold all or a portion of agreement funds if the recipient violates any term or condition of this financial assistance agreement. Termination for cause may be considered for evaluating future applications. The recipient may object to terminations with cause and may provide information and documentation challenging the termination.
2. **Termination for Convenience.** Both the Department and the recipient may terminate the financial assistance agreement, in whole or in part, when both parties agree that the continuation of the project would not produce beneficial results commensurate with the further expenditure of funds.
3. Financial assistance agreements are not transferable to any person or entity.
4. Department and the recipient remain responsible for compliance with all closeout requirements.

Y. **Enforcement; Remedies for Noncompliance.** If the recipient falsifies any award document or materially fails to comply with any term of this financial assistance agreement, the Department may take one or more of the following actions, as appropriate:

1. Suspend or terminate, in whole or part, the current agreement;

2. Disallow all or part of the cost of the activity or action not in compliance;
3. Temporarily withhold cash payments pending the recipient's correction of the deficiency;
4. Withhold further awards from the recipient;
5. Order the recipient not to transfer ownership of equipment purchased with assistance money without prior Department approval; or
6. Take other remedies that may be legally available, including cost recovery, breach of contract, and suspension or debarment.

Z. **Subgrantee's Signature.** The recipient's signature on the application and the award documents signifies the recipient's agreement to all of the terms and conditions of the financial assistance agreement.

AA. **Human Trafficking. This requirement applies to non-profit recipients or subrecipients.** The recipient, their employees, subrecipients under this agreement, and subrecipients' employees may not engage in severe forms of trafficking in persons during the period of time that the agreement is in effect; procure a commercial sex act during the period of time that the award is in effect; or use forced labor in the performance of the agreement or subagreements under the award. The department has the right to terminate unilaterally: (1) implement section 106(g) of the Trafficking Victims Protection Act of 2000 (TVPA), as amended, noncompliance that are available to the recipient under this agreement.

BB. **Illegal Immigration.** Any municipality that enacts or adopts a sanctuary policy will be ineligible for moneys provided through financial assistance agreements administered by any state agency or department until the policy is repealed or is no longer in effect (Missouri Statutes – RSMo 67.307 (2)). No business entity or employer shall knowingly employ, hire for employment, or continue to employ an unauthorized alien to perform work within the state of Missouri (RSMo 285.525 – 285.530).

CC. **Management Fees.** Management fees or similar charges in excess of the direct costs and approved indirect rates are not allowable. The term "management fees or similar charges" refers to expenses added to the direct costs in order to accumulate and reserve funds for ongoing business expenses, unforeseen liabilities, or for other similar costs which are not allowable under this agreement. Management fees or similar charges may not be used to improve or expand the project funded under this agreement, except to the extent authorized as a direct cost of carrying out the scope of work.

DD. Federal Funding Accountability and Transparency Act (FFATA)

Requirements. If the original assistance agreement amount is \$30,000 or more or an amendment increases the award amount to \$30,000 or greater, the recipient must submit the following to the Department prior to Department signing the amendment (Subrecipient Informational Form):

1. Location of the entity receiving the financial assistance and primary location of performance under the award, including city, state, congressional district and county;
2. A unique entity identifier of the entity receiving the financial assistance;
3. A unique entity identifier of the parent entity of the recipient; and
4. Names and total compensation for the five most highly compensated officers for the preceding completed fiscal year

EE. Executive Compensation. If FFATA reporting requirements apply and if the agreement period will exceed 12 months, the recipient must provide to the Department updated compensation information for their five most highly compensated officers using the Subrecipient Informational Form at the end of each 12 month period.

FF. Competency. The recipient ensures that all personnel associated with this financial assistance agreement, including staff, contractors and subrecipients, possess adequate education, training and experience to satisfactorily perform all technical tasks to be performed in order to fulfill the requirements of this agreement.

GG. Prohibition on certain telecommunications and video surveillance service or equipment. Recipient is prohibited from obligating or expending funds to procure or obtain; extend or renew a contract to procure or obtain; or enter into a contract to procure or obtain equipment, services, or systems that use covered telecommunications equipment or services as a substantial or essential component of any system, or as critical technology as part of any system.

As described in Public Law 115-232, section 889, covered telecommunications equipment is telecommunications equipment produced by Huawei Technologies Company or ZTE Corporation (or any subsidiary or affiliate of such entities).

(i) For the purpose of public safety, security of government facilities, physical security surveillance of critical infrastructure, and other national security purposes, video surveillance and telecommunications equipment produced by Hytera Communications Corporation, Hangzhou Hikvision Digital Technology Company, or Dahua Technology Company (or any subsidiary or affiliate of such entities).

(ii) Telecommunications or video surveillance services provided by such entities or using such equipment.

(iii) Telecommunications or video surveillance equipment or services produced or provided by an entity that the Secretary of Defense, in consultation with the Director of the National Intelligence or the Director of the Federal Bureau of Investigation, reasonably believes to be an entity owned or controlled by, or otherwise connected to, the government of a covered foreign country.

Consistent with 2 CFR 200.471, cost incurred for telecommunications and video surveillance services or equipment such as phones, internet, video surveillance, and cloud servers are allowable except for the following circumstances:

- a. Obligating or expending funds for covered telecommunications and video surveillance services or equipment or services as described in 2 CFR 200.216 to:
 - a. Procure or obtain, extend or renew a contract to procure or obtain;
 - b. Enter into a contract (or renew a contract) to procure, or
 - c. Obtain the equipment, services, or systems

II. **Statutory Requirements**

The recipient must comply with all federal, state and local laws relating to employment, construction, research, environmental compliance, and other activities associated with grants from the Department. Failure to abide by these laws is sufficient grounds to cancel the agreement. For a copy of state and federal laws that typically apply to financial assistance agreements contact the Department. By applying for this financial assistance agreement, the recipient certifies that the recipient, its board of directors and principals are in compliance with the specific federal and state laws set out below. Further, the recipient shall report to the Department any instance in which the recipient or any member of its board of directors or principals is determined by any administrative agency or by any court in connection with any judicial proceeding to be in noncompliance with any of the specific federal or state laws set forth below. Such report shall be submitted within ten (10) working days following such determination. Failure to comply with the reporting requirement may be grounds for termination of this financial assistance agreement or suspension or debarment of the recipient.

A. Laws and regulations related to nondiscrimination:

1. Title VI of the Civil Rights Act of 1964 (P.L. 88-352) which prohibits discrimination on the basis of race, color or national origin, including Limited English Proficiency (LEP);
2. Title VII of the Civil Rights Act of 1964 found at 42 U.S.C. §2000(e) et.seq. which prohibits discrimination on the basis of race, color, religion, national origin, or sex:

3. Title IX of the Education Amendments of 1972, as amended (U.S.C. §§ 1681-1683 and 1685-1686) which prohibits discrimination on the basis of sex;
4. Section 504 of the Rehabilitation Act of 1973, as amended (29 U.S.C. § 794), which prohibits discrimination on the basis of disability;
5. Age Discrimination Act of 1975, as amended (42 U.S.C. §§ 621-634), which prohibits discrimination on the basis of age;
6. Drug Abuse Office and Treatment Act of 1972 (P.L. 92-255), as amended, relating to nondiscrimination on the basis of drug abuse;
7. Comprehensive Alcohol Abuse and Alcoholism Prevention, Treatment and Rehabilitation Act of 1970 (P.L. 91-616), as amended, relating to nondiscrimination on the basis of alcohol abuse or alcoholism;
8. Sections 523 and 527 of the Public Health Service Act of 1912 (42 U.S.C. §§ 290 dd-3 and 290 ee-3), as amended, relating to confidentiality of alcohol and drug abuse patient records;
9. Title VIII of the Civil Rights Act of 1968 (42 U.S.C. § 3601 et seq.), as amended, relating to nondiscrimination in the sale, rental or financing of housing;
10. Chapter 213 of the Missouri Revised Statutes which prohibits discrimination on the basis of race, color, religion, national origin, sex, age, and disability.
11. The Americans with Disabilities Act (P. L. 101-336), 42 U. S. C. §12101 et seq., relating to nondiscrimination with respect to employment, public services, public accommodations and telecommunications.
12. Any other nondiscrimination provisions in the specific statute(s) and regulations under which application for federal assistance is being made.
13. The requirements of any other nondiscrimination statute(s) and regulations which may apply to the application.

- B. State and Federal Environmental Laws:
1. The Federal Clean Air Act, 42 U.S.C. § 7606, as amended, prohibiting award of assistance by way of grant, loan, or contract to noncomplying facilities.
 2. The Federal Water Pollution Control Act, 33 U.S.C. § 1368, as amended, prohibiting award of assistance by way of grant, loan, or contract to noncomplying facilities.
 3. The National Environmental Policy Act of 1969, 42 U.S.C. § 4321 et seq., as amended, particularly as it relates to the assessment of the environmental impact of federally assisted projects.
 4. The National Historic Preservation Act of 1966, 16 U.S.C. § 470 et seq., as amended, relating to the preservation of historic landmarks.
 5. Earthquakes - Seismic Building and Construction Ordinances, §§ 319.200 - 319.207, RSMo (Cum. Supp. 1990), relating to the adoption of seismic design and construction ordinances by certain cities, towns, villages and counties.
 6. The Missouri Clean Water Law, Sections 644.006 to 644.141, RSMo.
 7. The Missouri Hazardous Waste Management Law, Section, 260.350 to 260.430, RSMo.
 8. The Missouri Solid Waste Management Law, Sections 260.200 to 260.245, RSMo.
 9. The Missouri Air Conservation Law, Sections 643.101 to 643.190, RSMo.
- C. Uniform Relocation Assistance and Real Property Acquisition Policies Act of 1970, 42 U.S.C. §§ 4601 and 4651 et seq., relating to acquisition of interest in real property or any displacement of persons, businesses, or farm operations.
- D. The Hatch Act, 5 U.S.C. § 1501 et seq., as amended, relating to certain political activities of certain State and local employees.
- E. The Archaeological and Historic Preservation Act of 1974 (Public Law 93-291) relating to potential loss or destruction of significant scientific, historical, or archaeological data in connection with federally assisted activities.

- F. The Wild and Scenic Rivers Act of 1968 (16 U.S.C. § 1271 et seq.) related to protecting components or potential components of the national wild and scenic rivers system.
- G. The flood insurance purchase requirements of § 102(a) of the Flood Disaster Protection Act of 1973 (Public Law 93-234) which requires recipients in a special flood hazard area to participate in the program and to purchase flood insurance if the total cost of insurable construction and acquisition is \$10,000 or more.
- H. The Privacy Act of 1974, P.L. 93-579, as amended prohibiting the maintenance of information about any individual in a manner which would violate the provision of the Act.
- I. Public Law 93-348 regarding the protection of human subjects involved in research, development and related activities supported by this award of assistance.
- J. The Laboratory Animal Welfare Act of 1966 (P. L. 89-544), 7 U.S.C. § 2131 et seq., pertaining to the care, handling, and treatment of warm blooded animals held for research, teaching, or other activities supported by this award of assistance.
- K. The following additional requirements apply to projects that involve construction:
 - 1. The Davis-Bacon Act, as amended, 40 U.S.C. § 276a et seq., respecting wage rates for federally assisted construction contracts in excess of \$2000.
 - 2. The Copeland (Anti-Kickback) Act, 18 U.S.C. § 874, 40 U.S.C. § 276c.
 - 3. The Contract Work Hours and Safety Standards Act, 40 U.S.C. § 327 et seq.
 - 4. Convict labor shall not be used on construction projects unless by convicts who are on work release, parole, or probation.
 - 5. The Lead-Based Paint Poisoning Prevention Act (42 U. S. C. § 4801 et seq.) which prohibits the use of lead paint in construction or rehabilitation of residence structures.



**DIVISION OF
LABOR
STANDARDS**

MISSOURI DEPARTMENT OF LABOR AND INDUSTRIAL RELATIONS

AFFIDAVIT

COMPLIANCE WITH THE PREVAILING WAGE LAW

I, _____, upon being duly sworn upon my oath state that: (1) I am the
(Name)

_____ of _____; (2) all requirements of
(Title) *(Name of Company)*

§§ 290.210 to 290.340, RSMo, pertaining to the payment of wages to workers employed on public works projects
have been fully satisfied with regard to this company's work on _____;
(Name of Project)

(3) I have reviewed and am familiar with the prevailing wage rules in 8 CSR 30-3.010 to 8 CSR 30-3.060; (4) based upon my knowledge of these rules, including the occupational titles set out in 8 CSR 30-3.060, I have completed full and accurate records clearly indicating (a) the names, occupations, and crafts of every worker employed by this company in connection with this project together with an accurate record of the number of hours worked by each worker and the actual wages paid for each class or type of work performed, (b) the payroll deductions that have been made for each worker, and (c) the amounts paid to provide fringe benefits, if any, for each worker; (5) the amounts paid to provide fringe benefits, if any, were irrevocably made to a fund, plan, or program on behalf of the workers; (6) these payroll records are kept and have been provided for inspection to the authorized representative of the contracting public body and will be available, as often as may be necessary, to such body and the Missouri Department of Labor and Industrial Relations; (7) such records shall not be destroyed or removed from the state for one year following the completion of this company's work on this project; and (8) there has been no exception to the full and complete compliance with the provisions and requirements of Annual Wage Order No. _____ Section _____ issued by the Missouri Division of Labor Standards and applicable to this project located in _____ County, Missouri, and completed on the _____ day of _____, _____.

The matters stated herein are true to the best of my information, knowledge, and belief. I acknowledge that the falsification of any information set out above may subject me to criminal prosecution pursuant to §§290.340, 570.090, 575.040, 575.050, or 575.060, RSMo.

Signature

Subscribed and sworn to me this _____ day of _____, _____.

My commission expires _____, _____.

Notary Public

Receipt by Authorized Public Representative

**CERTIFICATION OF
NON-SEGREGATED FACILITIES**

The federally assisted construction contractor certifies that he/she does not maintain or provide for his/her employees any segregated facilities at any of his/her establishments, and that he/she does not permit his/her employees to perform their services at any location, under his/her control, where segregated facilities are maintained. The federally assisted construction contractor certifies further that he/she will not maintain or provide for his/her employees any segregated facilities at any of his/her establishments, and that he/she will not permit his/her employees to perform their services at any location, under his/her control, where segregated facilities are maintained. The federally assisted construction contractor agrees that a breach of this section is a violation of the Equal Opportunity Clause in this contract. As used in this caption, the term "segregated facilities" means any waiting rooms, work areas, restrooms and washrooms, restaurants and other eating areas, timeclocks, locker rooms and other storage or dressing areas, parking lots, drinking fountains, recreation or entertainment areas, transportation, and housing facilities provided for employees which are segregated by explicit directive or are in fact segregated on the basis of race, color, religion, or national of because of habit, local custom, or otherwise. The federally assisted construction contractor agrees that (except where he/she has obtained identical certifications from proposed subcontractors for specific time periods) he/she will obtain identical certifications from proposed subcontractors prior to the award of subcontracts exceeding \$10,000 which are not exempt from the provisions of the Equal Opportunity Clause, and that he/she will retain such certifications in his/her files.

NOTE-. The penalty for making false statements in offers is prescribed in 18 U. S. C. 1001.

Contractor Signature_____

Typed Name & Title _____ Date_____

U.S. Department of the Interior

**Certifications Regarding Debarment, Suspension and
Other Responsibility Matters, Drug-Free Workplace
Requirements and Lobbying**

Persons signing this form should refer to the regulations referenced below for complete instructions:

Certification Regarding Debarment, Suspension, and Other Responsibility Matters - Primary Covered Transactions - **The prospective primary participant further agrees by submitting this proposal that it will include the clause titled, "Certification Regarding Debarment, Suspension, Ineligibility and Voluntary Exclusion - Lower Tier Covered Transaction," provided by the department or agency entering into this covered transaction, without modification, in all lower tier covered transactions and in all solicitations for lower tier covered transactions.** See below for language to be used or use this form certification and sign. (See Appendix A of Subpart D of 43 CFR Part 12.)

Certification Regarding Debarment, Suspension, Ineligibility and Voluntary Exclusion - Lower Tier Covered Transactions - (See Appendix B of Subpart D of 43 CFR Part 12.)

Certification Regarding Drug-Free Workplace Requirements - Alternate I. (Grantees Other Than Individuals) and Alternate II. (Grantees Who are Individuals) - (See Appendix C of Subpart D of 43 CFR Part 12)

Signature on this form provides for compliance with certification requirements under 43 CFR Parts 12 and 18. The certifications shall be treated as a material representation of fact upon which reliance will be placed when the Department of the Interior determines to award the covered transaction, grant, cooperative agreement or loan.

**PART A: Certification Regarding Debarment, Suspension, and Other Responsibility Matters-
Primary Covered Transactions**

CHECK ___ IF THIS CERTIFICATION IS FOR A PRIMARY COVERED TRANSACTION AND IS APPLICABLE.

- (1) The prospective primary participant certifies to the best of its knowledge and belief, that it and its principals:
 - (a) Are not presently debarred, suspended, proposed for debarment, declared ineligible, or voluntarily excluded by any Federal department or agency;
 - (b) Have not within a three-year period preceding this proposal been convicted of or had a civil judgment rendered against them for commission of fraud or a criminal offense in connection with obtaining, attempting to obtain, or performing a public (Federal, State or local) transaction or contract under a public transaction; violation of Federal or State antitrust statutes or commission of embezzlement, theft, forgery, bribery, falsification or destruction of records, making false statements, or receiving stolen property;
 - (c) Are not presently indicted for or otherwise criminally or civilly charged by a governmental entity (Federal, State or local) with commission of any of the offenses enumerated in paragraph (1)(b) of this certification; and
 - (d) Have not within a three-year period preceding this application/proposal had one or more public transactions (Federal, State or local) terminated for cause or default.
- (2) Where the prospective primary participant is unable to certify to any of the statements in this certification, such prospective participant shall attach an explanation to this proposal.

**PART B: Certification Regarding Debarment, Suspension, Ineligibility and Voluntary Exclusion -
Lower Tier Covered Transactions**

CHECK ___ IF THIS CERTIFICATION IS FOR A LOWER TIER COVERED TRANSACTION AND IS APPLICABLE.

- (1) The prospective lower tier participant certifies, by submission of this proposal, that neither it nor its principals is presently debarred, suspended, proposed for debarment, declared ineligible, or voluntarily excluded from participation in this transaction by any Federal department or agency.
- (2) Where the prospective lower tier participant is unable to certify to any of the statements in this certification, such prospective participant shall attach an explanation to this proposal.

PART C: Certification Regarding Drug-Free Workplace Requirements

CHECK ___ IF THIS CERTIFICATION IS FOR AN APPLICANT WHO IS NOT AN INDIVIDUAL.

Alternate I. (Grantees Other Than Individuals)

A. The grantee certifies that it will or continue to provide a drug-free workplace by:

- (a) Publishing a statement notifying employees that the unlawful manufacture, distribution, dispensing, possession, or use of a controlled substance is prohibited in the grantee's workplace and specifying the actions that will be taken against employees for violation of such prohibition;
- (b) Establishing an ongoing drug-free awareness program to inform employees about--
 - (1) The dangers of drug abuse in the workplace;
 - (2) The grantee's policy of maintaining a drug-free workplace;
 - (3) Any available drug counseling, rehabilitation, and employee assistance programs; and
 - (4) The penalties that may be imposed upon employees for drug abuse violations occurring in the workplace;
- (c) Making it a requirement that each employee to be engaged in the performance of the grant be given a copy of the statement required by paragraph (a);
- (d) Notifying the employee in the statement required by paragraph (a) that, as a condition of employment under the grant, the employee will --
 - (1) Abide by the terms of the statement; and
 - (2) Notify the employer in writing of his or her conviction for a violation of a criminal drug statute occurring in the workplace no later than five calendar days after such conviction;
- (e) Notifying the agency in writing, within ten calendar days after receiving notice under subparagraph (d)(2) from an employee or otherwise receiving actual notice of such conviction. Employers of convicted employees must provide notice, including position title, to every grant officer on whose grant activity the convicted employee was working, unless the Federal agency has designated a central point for the receipt of such notices. Notice shall include the identification number(s) of each affected grant;
- (f) Taking one of the following actions, within 30 calendar days of receiving notice under subparagraph (d)(2), with respect to any employee who is so convicted --
 - (1) Taking appropriate personnel action against such an employee, up to and including termination, consistent with the requirements of the Rehabilitation Act of 1973, as amended; or
 - (2) Requiring such employee to participate satisfactorily in a drug abuse assistance or rehabilitation program approved for such purposes by a Federal, State, or local health, law enforcement, or other appropriate agency;
- (g) Making a good faith effort to continue to maintain a drug-free workplace through implementation of paragraphs (a) (b), (c), (d), (e) and (f).

B. The grantee may insert in the space provided below the site(s) for the performance of work done in connection with the specific grant:

Place of Performance (Street address, city, county, state, zip code)

Check ___ if there are workplaces on files that are not identified here.

PART D: Certification Regarding Drug-Free Workplace Requirements

CHECK ___ IF THIS CERTIFICATION IS FOR AN APPLICANT WHO IS AN INDIVIDUAL.

Alternate II. (Grantees Who Are Individuals)

- (a) The grantee certifies that, as a condition of the grant, he or she will not engage in the unlawful manufacture, distribution, dispensing, possession, or use of a controlled substance in conducting any activity with the grant;
- (b) If convicted of a criminal drug offense resulting from a violation occurring during the conduct of any grant activity, he or she will report the conviction, in writing, within 10 calendar days of the conviction, to the grant officer or other designee, unless the Federal agency designates a central point for the receipt of such notices. When notice is made to such a central point, it shall include the identification number(s) of each affected grant.

**PART E: Certification Regarding Lobbying
Certification for Contracts, Grants, Loans, and Cooperative Agreements**

*CHECK ___ IF CERTIFICATION IS FOR THE AWARD OF ANY OF THE FOLLOWING AND
THE AMOUNT EXCEEDS \$100,000: A FEDERAL GRANT OR COOPERATIVE AGREEMENT;
SUBCONTRACT, OR SUBGRANT UNDER THE GRANT OR COOPERATIVE AGREEMENT.*

*CHECK ___ IF CERTIFICATION FOR THE AWARD OF A FEDERAL
LOAN EXCEEDING THE AMOUNT OF \$150,000, OR A SUBGRANT OR
SUBCONTRACT EXCEEDING \$100,000, UNDER THE LOAN.*

The undersigned certifies, to the best of his or her knowledge and belief, that:

- (1) No Federal appropriated funds have been paid or will be paid, by or on behalf of the undersigned, to any person for influencing or attempting to influence an officer or employee of an agency, a Member of Congress, and officer or employee of Congress, or an employee of a Member of Congress in connection with the awarding of any Federal contract, the making of any Federal grant, the making of any Federal loan, the entering into of any cooperative agreement, and the extension, continuation, renewal, amendment, or modification of any Federal contract, grant, loan, or cooperative agreement.
- (2) If any funds other than Federal appropriated funds have been paid or will be paid to any person for influencing or attempting to influence an officer or employee of any agency, a Member of Congress, an officer or employee of Congress, or an employee of a Member of Congress in connection with this Federal contract, grant, loan, or cooperative agreement, the undersigned shall complete and submit Standard Form-LLL, "Disclosure Form to Report Lobbying," in accordance with its instructions.
- (3) The undersigned shall require that the language of this certification be included in the award documents for all subawards at all tiers (including subcontracts, subgrants, and contracts under grants, loans, and cooperative agreements) and that all subrecipients shall certify accordingly.

This certification is a material representation of fact upon which reliance was placed when this transaction was made or entered into. Submission of this certification is a prerequisite for making or entering into this transaction imposed by Section 1352, title 31, U.S. Code. Any person who fails to file the required certification shall be subject to a civil penalty of not less than \$10,000 and not more than \$100,000 for each such failure.

As the authorized certifying official, I hereby certify that the above specified certifications are true.

SIGNATURE OF AUTHORIZED CERTIFYING OFFICIAL

TYPED NAME AND TITLE

DATE

EXHIBIT
BUSINESS ENTITY CERTIFICATION, ENROLLMENT DOCUMENTATION,
AND AFFIDAVIT OF WORK AUTHORIZATION

BUSINESS ENTITY CERTIFICATION:

The project sponsor must certify their current business status by completing either Box A or Box B or Box C on this Exhibit.

- | | |
|---------------|---|
| BOX A: | To be completed by a non-business entity as defined below. |
| BOX B: | To be completed by a business entity who has not yet completed and submitted documentation pertaining to the federal work authorization program as described at http://www.dhs.gov/files/programs/gc_1185221678150.shtm . |
| BOX C: | To be completed by a business entity who has current work authorization documentation on file with a Missouri state agency including Division of Purchasing and Materials Management. |

Business entity, as defined in section 285.525, RSMo, pertaining to section 285.530, RSMo, is any person or group of persons performing or engaging in any activity, enterprise, profession, or occupation for gain, benefit, advantage, or livelihood. The term “**business entity**” shall include but not be limited to self-employed individuals, partnerships, corporations, contractors, and subcontractors. The term “**business entity**” shall include any business entity that possesses a business permit, license, or tax certificate issued by the state, any business entity that is exempt by law from obtaining such a business permit, and any business entity that is operating unlawfully without such a business permit. The term “**business entity**” shall not include a self-employed individual with no employees or entities utilizing the services of direct sellers as defined in subdivision (17) of subsection 12 of section 288.034, RSMo.

Note: Regarding governmental entities, business entity includes Missouri schools, Missouri universities (other than stated in Box C), out of state agencies, out of state schools, out of state universities, and political subdivisions. A business entity does not include Missouri state agencies and federal government entities.

BOX A – CURRENTLY NOT A BUSINESS ENTITY

I certify that _____ (**Company/Individual Name**) **DOES NOT CURRENTLY MEET** the definition of a business entity, as defined in section 285.525, RSMo pertaining to section 285.530, RSMo as stated above, because: (check the applicable business status that applies below)

- I am a self-employed individual with no employees; **OR**
- The company that I represent employs the services of direct sellers as defined in subdivision (17) of subsection 12 of section 288.034, RSMo.

I certify that I am not an alien unlawfully present in the United States and if _____ (**Company/Individual Name**) is awarded a Recreational Trails Program Grant for _____ (**Project Title**) and if the business status changes during the project period to become a business entity as defined in section 285.525, RSMo, pertaining to section 285.530, RSMo, then, prior to proceeding with the project as a business entity, _____ (**Company/Individual Name**) agrees to complete Box B, comply with the requirements stated in Box B and provide the Department of Natural Resources, Division of State Parks with all documentation required in Box B of this exhibit.

Authorized Representative's Name (Please Print)

Authorized Representative's Signature

Company Name (if applicable)

Date

EXHIBIT 1, continued

(Complete the following if you DO NOT have the E-Verify documentation and a current Affidavit of Work Authorization already on file with the State of Missouri. If completing Box B, do not complete Box C.)

BOX B – CURRENT BUSINESS ENTITY STATUS

I certify that _____ (Business Entity Name) **MEETS** the definition of a business entity as defined in section 285.525, RSMo, pertaining to section 285.530.

Authorized Business Entity Representative's
Name (Please Print)

Authorized Business Entity
Representative's Signature

Business Entity Name

Date

E-Mail Address

As a business entity, the project sponsor must perform/provide each of the following. The project sponsor should check each to verify completion/submission of all of the following:

- Enroll and participate in the E-Verify federal work authorization program (Website: http://www.dhs.gov/files/programs/gc_1185221678150.shtm; Phone: 888-464-4218; Email: e-verify@dhs.gov) with respect to the employees hired after enrollment in the program who are proposed to work in connection with the services required herein; AND
- Provide documentation affirming said company's/individual's enrollment and participation in the E-Verify federal work authorization program. Documentation shall include EITHER the E-Verify Employment Eligibility Verification page listing the project sponsor's name and company ID OR a page from the E-Verify Memorandum of Understanding (MOU) listing the project sponsor's name and the MOU signature page completed and signed, at minimum, by the project sponsor and the Department of Homeland Security – Verification Division. If the signature page of the MOU lists the project sponsor's name and company ID, then no additional pages of the MOU must be submitted; AND
- Submit a completed, notarized Affidavit of Work Authorization provided on the next page of this Exhibit.

EXHIBIT 1, continued

AFFIDAVIT OF WORK AUTHORIZATION:

The project sponsor who meets the section 285.525, RSMo, definition of a business entity must complete and return the following Affidavit of Work Authorization.

Comes now _____ (Name of Business Entity Authorized Representative) as _____ (Position/Title) first being duly sworn on my oath, affirm _____ (Business Entity Name) is enrolled and will continue to participate in the E-Verify federal work authorization program with respect to employees hired after enrollment in the program who are proposed to work in connection with the proposed Recreational Trails Program project with the State of Missouri for the duration of the contract(s), if awarded in accordance with subsection 2 of section 285.530, RSMo. I also affirm that _____ (Business Entity Name) does not and will not knowingly employ a person who is an unauthorized alien in connection with the proposed Recreational Trails Program project for the duration of the project period, if awarded.

In Affirmation thereof, the facts stated above are true and correct. (The undersigned understands that false statements made in this filing are subject to the penalties provided under section 575.040, RSMo.)

_____ Authorized Representative's Signature	_____ Printed Name
_____ Title	_____ Date
_____ E-Mail Address	_____ E-Verify Company ID Number

Subscribed and sworn to before me this _____ of _____. I am
(DAY) (MONTH, YEAR)
commissioned as a notary public within the County of _____, State of
(NAME OF COUNTY)
_____, and my commission expires on _____.
(NAME OF STATE) (DATE)

Signature of Notary

Date

EXHIBIT 1, continued

(Complete the following if you have the E-Verify documentation and a current Affidavit of Work Authorization already on file with the State of Missouri. If completing Box C, do not complete Box B.)

BOX C – AFFIDAVIT ON FILE - CURRENT BUSINESS ENTITY STATUS

I certify that _____ (**Business Entity Name**) **MEETS** the definition of a business entity as defined in section 285.525, RSMo, pertaining to section 285.530, RSMo, and have enrolled and currently participates in the E-Verify federal work authorization program with respect to the employees hired after enrollment in the program who are proposed to work in connection with the Recreational Trails Program project with the State of Missouri. We have previously provided documentation to a Missouri state agency or public university that affirms enrollment and participation in the E-Verify federal work authorization program. The documentation that was previously provided included the following.

- ✓ The E-Verify Employment Eligibility Verification page OR a page from the E-Verify Memorandum of Understanding (MOU) listing the project sponsor’s name and the MOU signature page completed and signed by the project sponsor’s and the Department of Homeland Security – Verification Division
- ✓ A current, notarized Affidavit of Work Authorization (must be completed, signed, and notarized within the past twelve months).

Name of **Missouri State Agency** or **Public University*** to Which Previous E-Verify Documentation Submitted:

(*Public University includes the following five schools under chapter 34, RSMo: Harris-Stowe State University – St. Louis; Missouri Southern State University – Joplin; Missouri Western State University – St. Joseph; Northwest Missouri State University – Maryville; Southeast Missouri State University – Cape Girardeau.)

Date of Previous E-Verify Documentation Submission: _____

Previous **Bid/Contract Number** for Which Previous E-Verify Documentation Submitted: _____
(if known)

Authorized Business Entity Representative’s
Name (Please Print)

Authorized Business Entity
Representative’s Signature

E-Verify MOU Company ID Number

E-Mail Address

Business Entity Name

Date

FOR STATE USE ONLY

Documentation Verification Completed By:

Buyer

Date

CERTIFICATE OF MATERIALS ORIGIN

FEDERAL PROJECT NUMBER		STATE PROJET NUMBER	
ITEM DESCRIPTION		BID ITEM NUMBER	
INVOICE NUMBER		QUANTITY	
DATE RECEIVED		BILL OF LADING No.	

MATERIAL SOURCE (NAME AND ADDRESS) TO INCLUDE EACH SUPPLIER, FABRICATOR, AND MANUFACTURER INCLUDING HEAT/BATCH NUMBERS IF AVAILABLE

MATERIAL DESCRIPTION

DESCRIPTION OF MATERIALS OF UNKNOWN ORIGIN OR FOREIGN MATERIALS DELIVERED TO THE PROJECT

This certification is made for the purpose of establishing the materials acceptance under the Buy America Certification (23CFR 635.410) and the Contract Special Provisions. All iron and steel manufacturing processes, including protective coating for the domestic materials described above occurred in the United States of America. Manufacturer's certificates verify the origin above described in the domestic materials and will be kept on file for three years by the suppliers following final payment. Copies will be provided to the Missouri Department of Natural Resources upon request.

I declare under penalty of perjury under the Missouri and Federal Laws that the foregoing is true and correct.

Company Name and Address	Authorized Representative
	<p>Name:</p> <p>Title:</p> <p>Signature:</p> <p>Date:</p>

CERTIFICATE OF MATERIALS ORIGIN (NON-IRON/STEEL)

FEDERAL PROJECT NUMBER		STATE PROJECT NUMBER	
ITEM DESCRIPTION		BID ITEM NUMBER	
INVOICE NUMBER		QUANTITY	
DATE RECEIVED		BILL OF LADING No.	

MATERIAL SOURCE (NAME AND ADDRESS) TO INCLUDE EACH SUPPLIER, FABRICATOR, AND MANUFACTURER INCLUDING HEAT/BATCH NUMBERS IF AVAILABLE

MATERIAL DESCRIPTION

DESCRIPTION OF MATERIALS OF UNKNOWN ORIGIN OR FOREIGN MATERIALS DELIVERED TO THE PROJECT

This certification is made for the purpose of establishing the materials acceptance under the Buy America requirements in the Jobs ACT legislation which includes Build America, Buy America Act Publication L. No. 117-68. This certification is for the additional construction material requirements to be domestically produced in addition to the existing steel and iron Buy America requirements. The construction material origin and any manufacturing processes for this product shall all be performed domestically in the United States of America. Manufacturer's certificates shall verify the origin above described in the domestic materials and will be kept on file for three years by the suppliers following final payment. Copies will be provided to the Missouri Department of Natural Resources upon request.

I declare to the best of my knowledge under penalty of perjury under the Missouri and Federal Laws that the foregoing is true and correct.

Company Name and Address	Authorized Representative
	Name: Title: Signature: Date:

Recreational Trails Program

Accessibility Checklist

Project

Project No.

Location

Date Inspected

Name of Person Completing Inspection

Project Sponsor

Contact Information

Comments



Use of the ADA checklist is by permission of the New England ADA Center (<http://www.adachecklist.org>) and has been modified with their consent to include trail-specific standards. Graphics courtesy of the New England ADA Center, the U.S. Forest Service and the U.S. Access Board.

1. Trailhead

Comments

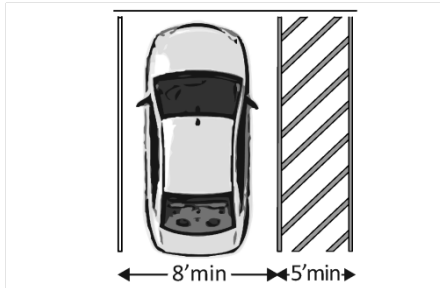
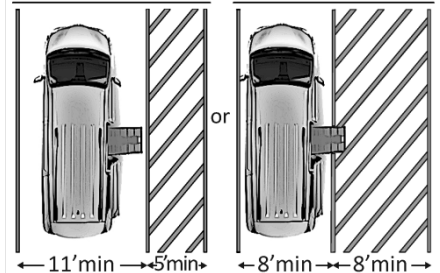
Parking Accessible parking spaces should be identified by size, access aisle and signage.

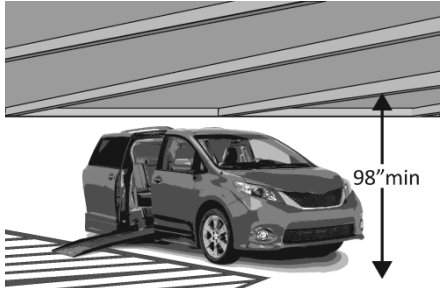
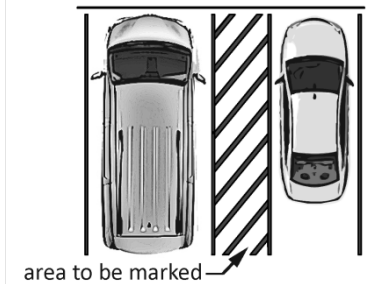
<p>1.1 If parking is provided for the public, are an adequate number of accessible spaces provided? [2010 ADA Standards for Accessible Design – 208.2]</p>	<input type="checkbox"/> Yes <input type="checkbox"/> Not applicable	<table border="1"> <thead> <tr> <th>Total Spaces</th> <th>Accessible Spaces</th> </tr> </thead> <tbody> <tr> <td>1 - 25</td> <td>1</td> </tr> <tr> <td>26 - 50</td> <td>2</td> </tr> <tr> <td>51 - 75</td> <td>3</td> </tr> <tr> <td>76 - 100</td> <td>4</td> </tr> <tr> <td colspan="2">100+ see 2010 Standards 208.2</td> </tr> </tbody> </table>	Total Spaces	Accessible Spaces	1 - 25	1	26 - 50	2	51 - 75	3	76 - 100	4	100+ see 2010 Standards 208.2		<p>Total number of parking spaces: Number of accessible parking spaces: If “Not applicable” marked, indicate why:</p>
Total Spaces	Accessible Spaces														
1 - 25	1														
26 - 50	2														
51 - 75	3														
76 - 100	4														
100+ see 2010 Standards 208.2															
<p>1.2 Of the accessible spaces, is at least one a van-accessible space?*[208.2.4]</p>	<input type="checkbox"/> Yes <input type="checkbox"/> No applicable	<p>*For every 6 or fraction of 6 parking spaces required by the table above, at least 1 should be a van-accessible space.</p>	<p>Number of van-accessible spaces: If “Not applicable” marked, indicate why:</p>												
<p>1.3 Are accessible spaces at least 8 feet wide with an access aisle at least 5 feet wide? [502.2, 502.3]</p> <p>Note: Two spaces may share an access aisle. Check state/local requirements; some specify that each space have its own aisle.</p>	<input type="checkbox"/> Yes <input type="checkbox"/> Not applicable		<p>Width of accessible parking space (in feet): Width of access aisle (in feet): If “Not applicable” marked, indicate why:</p>												
<p>1.4 Is the van accessible space: At least 11 feet wide with an access aisle at least 5 feet wide? Or At least 8 feet wide with an access aisle at least 8 feet wide?</p>	<input type="checkbox"/> Yes <input type="checkbox"/> Not applicable		<p>Width of van-accessible space (in feet): Width of access aisle (in feet): If “Not applicable” marked, indicate why:</p>												

[502.2]			
<p>1.5 Is at least 98 inches of vertical clearance provided for the van accessible space? [502.5]</p>	<input type="checkbox"/> Yes <input type="checkbox"/> Not applicable		<p>Measurement of vertical clearance (in inches):</p> <p>If "Not applicable" marked, indicate why:</p>
<p>1.6 Are the access aisles marked so as to discourage parking in them? [502.3.3]</p> <p>Note: The marking method and color may be addressed by state/local requirements.</p>	<input type="checkbox"/> Yes <input type="checkbox"/> Not applicable		<p>If "Not applicable" marked, indicate why:</p>
<p>1.7 Is the slope of the accessible parking spaces and access aisles no steeper than 1:48 (less than 2%) in all directions? [502.4]</p>	<input type="checkbox"/> Yes <input type="checkbox"/> Not applicable		<p>Slope measurement:</p> <p>If "Not applicable" marked, indicate why:</p>

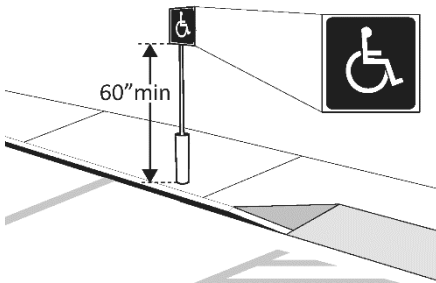
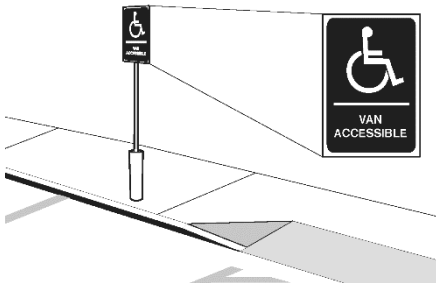
<p>1.8 Do the access aisles adjoin an accessible route? [502.3]</p>	<p><input type="checkbox"/> Yes</p> <p><input type="checkbox"/> Not applicable</p>		<p>If "Not applicable" marked, indicate why:</p>
<p>1.9 Are accessible spaces identified with a sign that includes the International Symbol of Accessibility?</p> <p>Is the bottom of the sign at least 60 inches above the ground? [502.6]</p> <p>Note: The International Symbol of Accessibility is not required on the ground.</p>	<p><input type="checkbox"/> Yes</p> <p><input type="checkbox"/> Not applicable</p>		<p>Measurement from bottom of sign to ground (in inches):</p> <p>If "Not applicable" marked, indicate why:</p>
<p>1.10 Are there signs reading "van accessible" at van accessible spaces? [502.6]</p>	<p><input type="checkbox"/> Yes</p> <p><input type="checkbox"/> Not applicable</p>		<p>If "Not applicable" marked, indicate why:</p>
<p>1.11 Of the total parking spaces, are the accessible spaces located on the closest accessible route to the accessible entrance(s)? [208.3.1]</p> <p>Note: If parking serves multiple entrances, accessible</p>	<p><input type="checkbox"/> Yes</p> <p><input type="checkbox"/> Not applicable</p>		<p>If "Not applicable" marked, indicate why:</p>

parking should be dispersed.

--

--

--

Accessible Route

1.12 Is there at least one route from site arrival points (parking, passenger loading zones, or sidewalk) that does not require the use of stairs? [206.2.1]

- Yes
 Not Applicable

If yes, location of route:
 If "Not applicable" marked, indicate why:

1.13 Is the route stable, firm and slip-resistant? [302.1]

- Yes
 Not applicable

If "Not applicable" marked, indicate why:



1.14 Is the route at least 36 inches wide? [403.5.1]

- Yes
 Not applicable

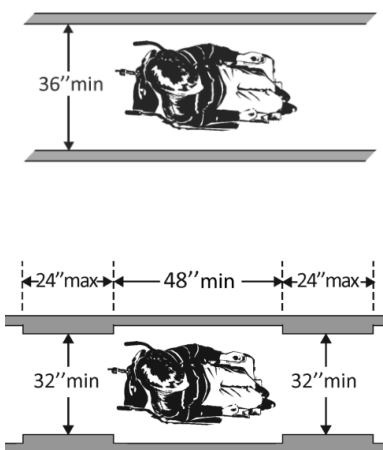
Note: The accessible route can narrow to 32 inches min. for a max. of 24 inches. These narrower portions of the route must be at least 48 inches from each other.

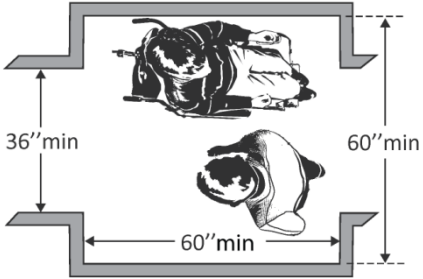

Measurement of access route (in inches):
 If "Not applicable" marked, indicate why:

<p>1.15 If the route is greater than 200 feet in length and less than 60 inches wide, is there a passing space no less than 60 x 60 inches? [403.5.3]</p>	<p><input type="checkbox"/> Yes</p> <p><input type="checkbox"/> Not applicable</p>		<p>If "Not applicable" marked, indicate why:</p>
<p>1.16 On unpaved or natural surface accessible routes, are tread obstacles less than two inches high?</p> <p>OR</p> <p>On an accessible route of paved material (asphalt, concrete, paving blocks, and so forth) or built with boards (wood planks, heavy timber, concrete, fiberglass, or other manufactured material), are tread obstacles a maximum of one-half inch in height at their highest point?</p> <p>AND</p> <p>On any accessible route, are obstacles separated by a minimum of 48 inches where possible, particularly where obstacles cross the entire tread width? [See Outdoor Developed Areas: A Summary of</p>	<p><input type="checkbox"/> Yes</p> <p><input type="checkbox"/> Not applicable</p> <p><input type="checkbox"/> Yes</p> <p><input type="checkbox"/> Not applicable</p> <p><input type="checkbox"/> Yes</p> <p><input type="checkbox"/> Not applicable</p>		<p>If "Not applicable" marked, indicate why:</p>

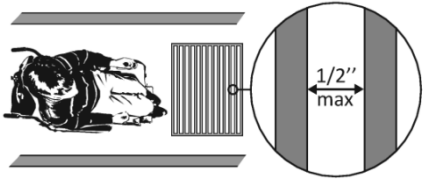
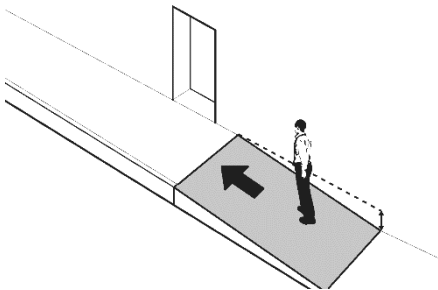
<p>Accessibility Standards for Federal Outdoor Developed Areas – 1016.5]</p>			
<p>1.17 If there are grates or openings on the route, are the openings no larger than ½ inches?</p> <p>Is the long dimension perpendicular to the dominant direction of travel? [See 2010 ADA Standards for Accessible Design – 302.3]</p>	<p><input type="checkbox"/> Yes</p> <p><input type="checkbox"/> Not applicable</p> <p><input type="checkbox"/> Yes</p> <p><input type="checkbox"/> Not applicable</p>	 <p>The diagram illustrates a dog on a grate. A circular callout provides a magnified view of the grate's openings, with a double-headed arrow indicating a maximum width of 1/2 inch.</p>	<p>Measurement of grate openings (in inches):</p> <p>If “Not applicable” marked, indicate why:</p>
<p>1.18 Is the running slope of the access route no steeper than 1:20, i.e. for every inch of height change there are at least 20 inches of route run? [403.3]</p> <p>Note: If the running slope is steeper than 1:20, treat as a ramp and add features such as edge protection and handrails.</p>	<p><input type="checkbox"/> Yes</p> <p><input type="checkbox"/> No</p>	 <p>The diagram shows a person walking up a ramp. A dashed line indicates the slope measurement, and an arrow points in the direction of travel.</p>	<p>Slope measurement:</p> <p>If “Not applicable” marked, indicate why:</p>

1.19

Is the cross slope of the
access route no steeper than
1:48?
[403.3]

Yes

Not applicable

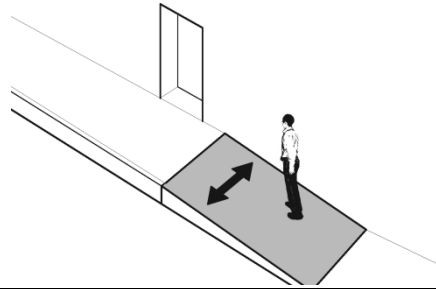

Slope measurement:

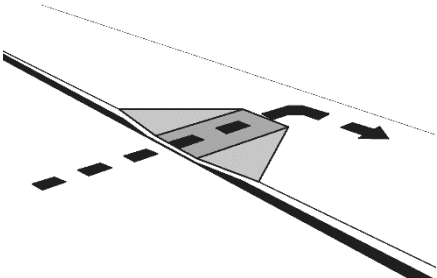
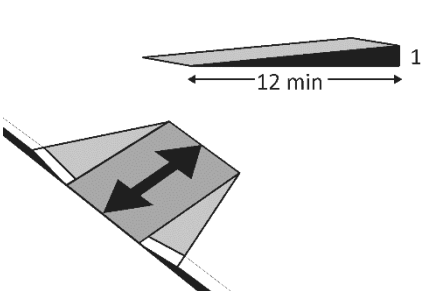
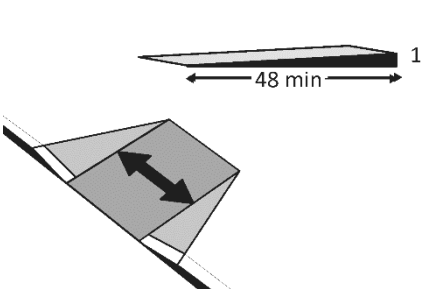
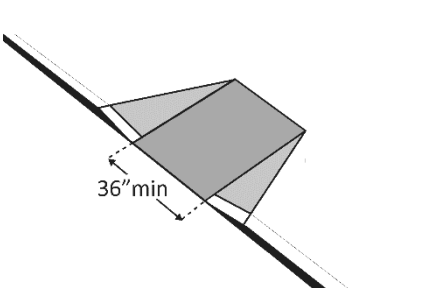

If "Not applicable" marked, indicate why:

Curb Ramps

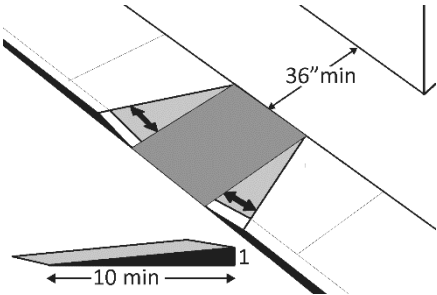
<p>1.20 If the accessible route crosses a curb, is there a curb ramp? [402.2]</p>	<p><input type="checkbox"/> Yes</p> <p><input type="checkbox"/> Not applicable</p>		<p>If "Not applicable" marked, indicate why:</p>
<p>1.21 Is the running slope of the curb ramp no steeper than 1:12, i.e. for every inch of height change there are at least 12 inches of curb ramp run? [406.1, 405.2]</p>	<p><input type="checkbox"/> Yes</p> <p><input type="checkbox"/> Not applicable</p>		<p>Slope measurement (in inches):</p> <p>If "Not applicable" marked, indicate why:</p>
<p>1.22 Is the cross slope of the curb ramp, excluding flares, no steeper than 1:48? [406.1, 405.3]</p>	<p><input type="checkbox"/> Yes</p> <p><input type="checkbox"/> Not applicable</p>		<p>Cross slope measurement (in inches):</p> <p>If "Not applicable" marked, indicate why:</p>
<p>1.23 Is the curb ramp, excluding flares, at least 36 inches wide? [406.1, 405.5]</p>	<p><input type="checkbox"/> Yes</p> <p><input type="checkbox"/> Not applicable</p>		<p>Measurement of ramp width (in inches):</p> <p>If "Not applicable" marked, indicate why:</p>

<p>1.24 At the top of the curb ramp is there a level landing (slope no steeper than 1:48 or 2% in all directions) that is at least 36 inches long and at least as wide as the curb ramp? [406.4]</p> <p>If there are curb ramp flares, are the slopes of the flares no steeper than 1:10, i.e. for every inch of height change there are at least 10 inches of flare run? [406.3]</p>	<p><input type="checkbox"/> Yes</p> <p><input type="checkbox"/> Not applicable</p> <p><input type="checkbox"/> Yes</p> <p><input type="checkbox"/> Not applicable</p>		<p>Measurement of landing (in inches):</p> <p>Measurement of slope of curb ramp flares (in inches):</p> <p>If "Not applicable" marked, indicate why:</p>
---	--	--	--

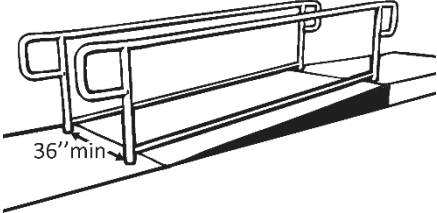
Ramps If any portion of the accessible route is steeper than 1:20, it should be treated as a ramp.

<p>1.26 If there is a ramp, is it at least 36 inches wide? [405.5]</p> <p>Note: If there are handrails, measure between the handrails.</p>	<p><input type="checkbox"/> Yes</p> <p><input type="checkbox"/> Not applicable</p>		<p>Measurement of width of ramp (in inches):</p> <p>If "Not applicable" marked, indicate why:</p>
<p>1.27 Is the surface stable, firm and slip resistant? [405.4]</p>	<p><input type="checkbox"/> Yes</p> <p><input type="checkbox"/> Not applicable</p>		<p>If "Not applicable" marked, indicate why:</p>
<p>1.28 For each section of the ramp, is the running slope no greater than 1:12, i.e. for every inch of height change there are at least 12 inches of ramp run? [405.2]</p>	<p><input type="checkbox"/> Yes</p> <p><input type="checkbox"/> Not applicable</p>		<p>Measurement of slope of ramp (in inches):</p> <p>If "Not applicable" marked, indicate why:</p>

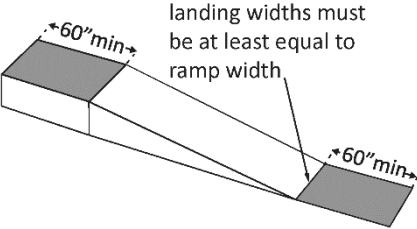
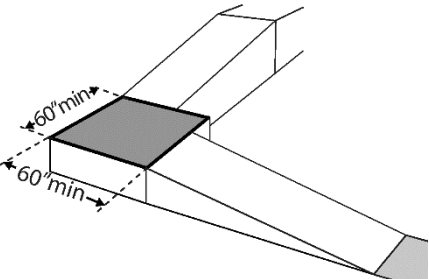
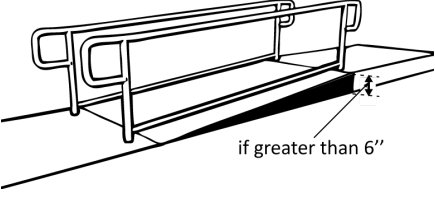

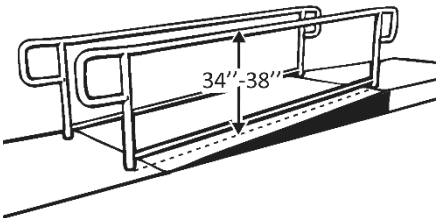
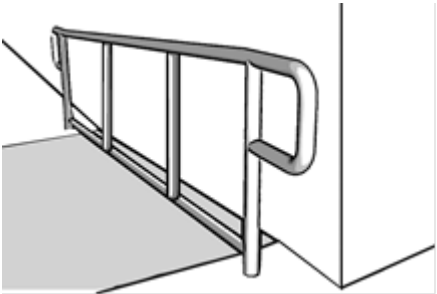
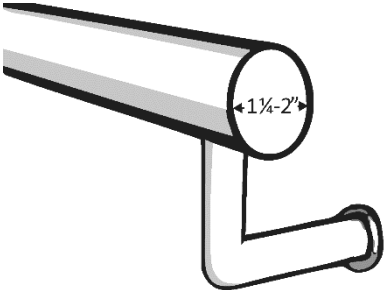
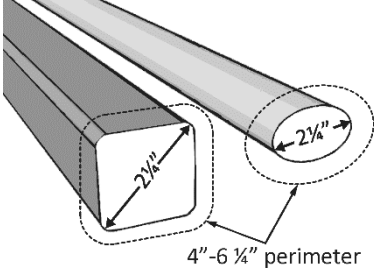
<p>1.29 Is there a level landing that is at least 60 inches long and at least as wide as the ramp:</p> <p>At the top of the ramp?</p> <p>At the bottom of the ramp? [405.7.2, 405.7.3]</p>	<p><input type="checkbox"/> Yes</p> <p><input type="checkbox"/> Not applicable</p> <p><input type="checkbox"/> Yes</p> <p><input type="checkbox"/> Not applicable</p>		<p>Measurement of level landing at top of ramp (in inches):</p> <p>Measurement of level landing at bottom of ramp (in inches):</p> <p>If "Not applicable" marked, indicate why:</p>
<p>1.30 Is there a level landing where the ramp changes direction that is at least 60 x 60 inches? [405.7.4]</p>	<p><input type="checkbox"/> Yes</p> <p><input type="checkbox"/> Not applicable</p>		<p>Measurement of landing between directional changes (In inches):</p> <p>If "Not applicable" marked, indicate why:</p>
<p>1.31 If the ramp has a rise higher than 6 inches, are there handrails on both sides? [405.8]</p> <p>Note: Curb ramps are not required to have handrails.</p>	<p><input type="checkbox"/> Yes</p> <p><input type="checkbox"/> Not applicable</p>		<p>Measurement of ramp rise (in inches):</p> <p>If "Not applicable" marked, indicate why:</p>

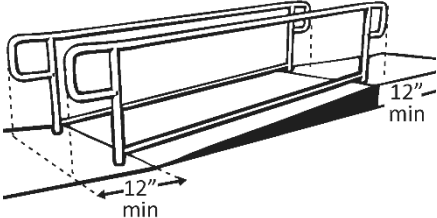
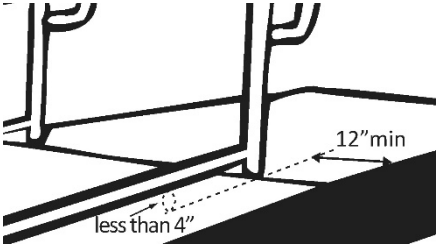
<p>1.32 Is the top of the handrail gripping surface no less than 34 inches and no greater than 38 inches above the ramp surface? [505.4]</p>	<p><input type="checkbox"/> Yes</p> <p><input type="checkbox"/> Not applicable</p>		<p>Measurement of distance of top of handrail from ramp surface (in inches):</p> <p>If "Not applicable" marked, indicate why:</p>
<p>1.33 Is the handrail gripping surface continuous and not obstructed along the top or sides? [505.3]</p> <p>If there are obstructions, is the bottom of the gripping surface obstructed no greater than 20%? [505.6]</p>	<p><input type="checkbox"/> Yes</p> <p><input type="checkbox"/> Not applicable</p> <p><input type="checkbox"/> Yes</p> <p><input type="checkbox"/> Not applicable</p>		<p>If "Not applicable" marked, indicate why:</p>
<p>1.34 If the handrail gripping surface is circular, is it no less than 1 ¼ inches and no greater than 2 inches in diameter? [505.7.1]</p>	<p><input type="checkbox"/> Yes</p> <p><input type="checkbox"/> Not applicable</p>		<p>Diameter of handrail gripping surface (in inches):</p> <p>If "Not applicable" marked, indicate why:</p>
<p>1.35 If the handrail gripping surface is non-circular:</p> <p>Is the perimeter no less than 4 inches and no greater than 6 ¼ inches?</p>	<p><input type="checkbox"/> Yes</p> <p><input type="checkbox"/> Not applicable</p>		<p>Perimeter of handrail gripping surface (in inches):</p> <p>Cross section of handrail gripping surface (in inches):</p> <p>If "Not applicable" marked, indicate why:</p>

<p>Is the cross section no greater than 2¼ inches? [505.7.2]</p>	<p><input type="checkbox"/> Yes</p> <p><input type="checkbox"/> Not applicable</p>		
<p>1.36 Does the handrail:</p> <p>Extend at least 12 inches horizontally beyond the top and bottom of the ramp?</p> <p>Return to a wall, guard, or landing surface? [505.10.1]</p>	<p><input type="checkbox"/> Yes</p> <p><input type="checkbox"/> Not applicable</p> <p><input type="checkbox"/> Yes</p> <p><input type="checkbox"/> Not applicable</p>		<p>Length of handrail beyond the top and bottom of ramp (in inches):</p> <p>If "Not applicable" marked, indicate why:</p>
<p>1.37 To prevent wheelchair casters and crutch tips from falling off:</p> <p>Does the surface of the ramp extend at least 12 inches beyond the inside face of the handrail?</p> <p>OR</p> <p>Is there a curb or barrier that prevents the passage of a 4-inch diameter sphere? [405.9.1, 405.9.2]</p>	<p><input type="checkbox"/> Yes</p> <p><input type="checkbox"/> Not applicable</p> <p><input type="checkbox"/> Yes</p> <p><input type="checkbox"/> Not applicable</p>		<p>Distance of surface of ramp beyond the inside face of the handrail (in inches):</p> <p>If "Not applicable" marked, indicate why:</p>

2. Toilet Rooms

Comments

<p>2.1 If toilet rooms are available to the public, is at least one toilet room accessible? (Either one for each sex, or one unisex.)</p>	<input type="checkbox"/> Yes <input type="checkbox"/> Not applicable		<p>If “Not applicable” marked, indicate why:</p>
<p>2.2 Are there signs at inaccessible toilet rooms that give directions to accessible toilet rooms? [See 2010 ADA Standards for Accessible Design – 216.8]</p>	<input type="checkbox"/> Yes <input type="checkbox"/> Not applicable		<p>If “Not applicable” marked, indicate why:</p>
<p>2.3 Is there a sign at the accessible toilet room with the International Symbol of Accessibility? [216.8]</p>	<input type="checkbox"/> Yes <input type="checkbox"/> Not applicable		<p>If “Not applicable” marked, indicate why:</p>

Accessible Route

<p>2.4 Is there an accessible route to the accessible toilet room? [206.2.4]</p>	<input type="checkbox"/> Yes <input type="checkbox"/> Not applicable		<p>If “Not applicable” marked, indicate why:</p>
---	---	--	--

Signs at Toilet Rooms

<p>2.5 Do text characters contrast with their backgrounds? [703.5]</p>	<input type="checkbox"/> Yes <input type="checkbox"/> Not applicable		<p>If “Not applicable” marked, indicate why:</p>
---	---	--	--

Are text characters raised?
[703.2]

Yes

Is there Braille?
[703.3]

Not applicable

Is the sign mounted on the wall on the latch side of the door?
[703.4.2]

Yes

Note: Signs are permitted on the push side of doors with closers and without hold-open devices.

Not applicable

Is the sign mounted on the wall so that a clear floor space of 18 inches minimum by 18 inches minimum, centered on the tactile characters, is provided beyond the arc of any door swing between the closed position and 45 degree open position?
[703.4.2]

Yes

Not applicable

Is the sign mounted on the wall so that the baseline of the lowest character is at least 48 inches above the floor and the baseline of the highest character is no more than 60 inches above the floor?

Yes

Not applicable

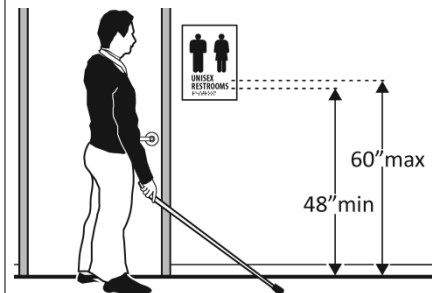
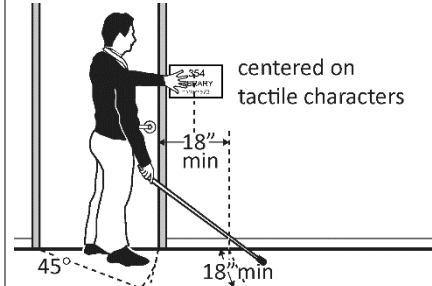
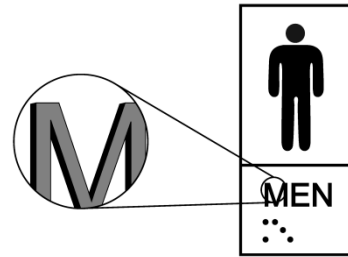

[703.4.1]

Note: If the sign is at double doors with one active leaf, the sign should be on the inactive leaf; if both leaves are active, the sign should be on the wall to the right of the right leaf.

Entrance

2.6 Is the door opening width at least 32 inches clear, between the face of the door and the stop, when the door is open 90 degrees?
[404.2.3]

- Yes
- Not applicable

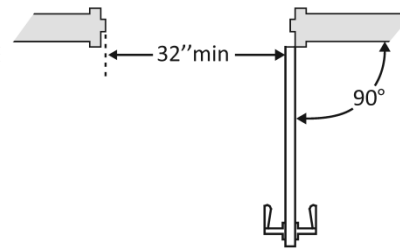

Measurement of door opening (in inches):
If "Not applicable" marked, indicate why:

2.7 If there is a front approach to the pull side of the door, is there at least 18 inches of maneuvering clearance beyond the latch side plus 60 inches clear depth?

- Yes
- Not applicable

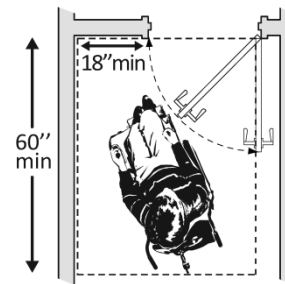



Measurement of clearance on latch side:
Measurement of depth clearance:
Slope measurement:
If "Not applicable" marked, indicate why:

On both sides of the door, is the floor surface of the maneuvering clearance level (no steeper than 1:48)?
[404.2.4]

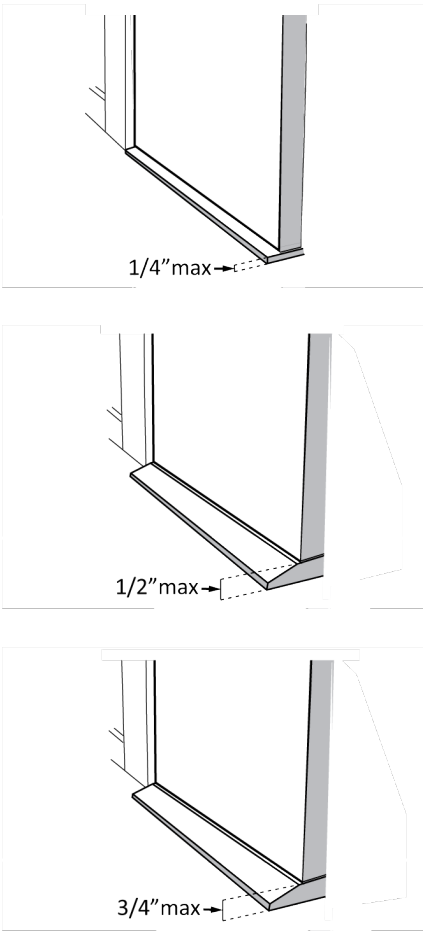
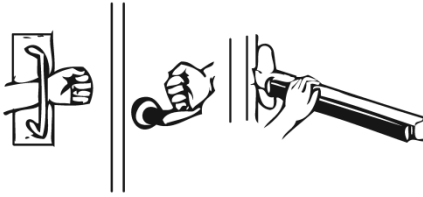
- Yes
- Not applicable

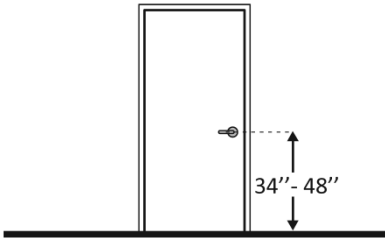
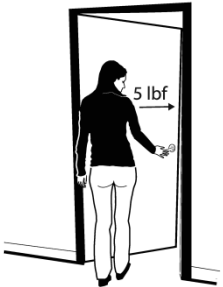
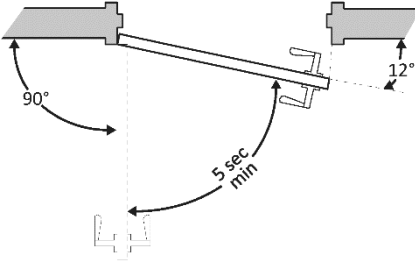
<p>2.8 If the threshold is vertical is it no more than ¼ inch high?</p> <p>Or</p> <p>No more than ½ inch high with the top ¼ inch beveled no steeper than 1:2, if the threshold was installed on or after the 1991 ADA Standards went into effect (1/26/93)?</p> <p>Or</p> <p>No more than ¾ inch high with the top ½ inch beveled no steeper than 1:2, if the threshold was installed before the 1991 ADA Standards went into effect (1/26/93)? [404.2.5, 303.2]</p> <p>Note: The first ¼ inch of the ½ or ¾ inch threshold may be vertical; the rest must be beveled.</p>	<p><input type="checkbox"/> Yes</p> <p><input type="checkbox"/> Not applicable</p> <p><input type="checkbox"/> Yes</p> <p><input type="checkbox"/> Not applicable</p> <p><input type="checkbox"/> Yes</p> <p><input type="checkbox"/> Not applicable</p>	 <p>The diagrams illustrate three different threshold configurations. The first diagram shows a vertical threshold with a maximum height of 1/4 inch. The second diagram shows a beveled threshold with a maximum height of 1/2 inch. The third diagram shows a beveled threshold with a maximum height of 3/4 inch. Each diagram includes a dashed line and an arrow indicating the measurement point.</p>	<p>Measurement of threshold:</p> <p>If “Not applicable” marked, indicate why:</p>
<p>2.9 Is the door equipped with hardware that is operable with one hand and does not require tight grasping, pinching or twisting of the wrist? [404.2.7]</p>	<p><input type="checkbox"/> Yes</p> <p><input type="checkbox"/> Not applicable</p>	 <p>The diagram shows three examples of one-handed door hardware operation. The first shows a hand operating a lever handle. The second shows a hand operating a round knob. The third shows a hand operating a long, horizontal grip handle.</p>	<p>If “Not applicable” marked, indicate why:</p>

<p>2.10 Are the operable parts of the door hardware mounted no less than 34 inches and no greater than 48 inches above the floor? [404.2.7]</p>	<p><input type="checkbox"/> Yes</p> <p><input type="checkbox"/> Not applicable</p>		<p>Measurement of distance between door hardware and floor (in inches):</p> <p>If “Not applicable” marked, indicate why:</p>
<p>2.11 For an interior door, can the door be opened easily (5 pounds maximum force)? [404.2.9]</p> <p>Note: You can use a pressure gauge or fish scale to measure force. If you do not have one you will need to judge whether the door is easy to open.</p>	<p><input type="checkbox"/> Yes</p> <p><input type="checkbox"/> Not applicable</p>		<p>If “Not applicable” marked, indicate why:</p>
<p>2.12 If the door has a closer, does it take at least 5 seconds to close from an open position of 90 degrees to a position of 12 degrees from the latch? [404.2.8.1]</p>	<p><input type="checkbox"/> Yes</p> <p><input type="checkbox"/> Not applicable</p>		<p>If “Not applicable” marked, indicate why:</p>
<p>2.13 If there are two doors in a series, e.g. vestibule, is the distance between the doors at least 48 inches plus the width of the doors when swinging into the space? [404.2.6]</p>	<p><input type="checkbox"/> Yes</p> <p><input type="checkbox"/> Not applicable</p>	 <p style="text-align: center;">or</p> 	<p>Measurement of distance between doors (in inches):</p> <p>If “Not applicable” marked, indicate why:</p>

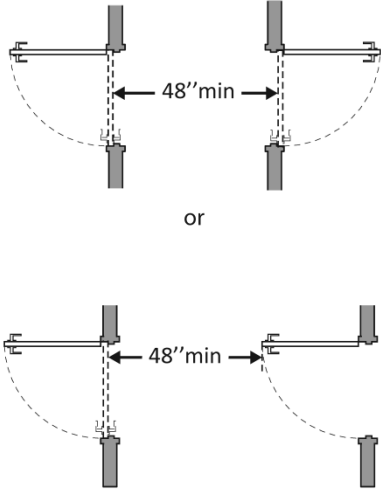
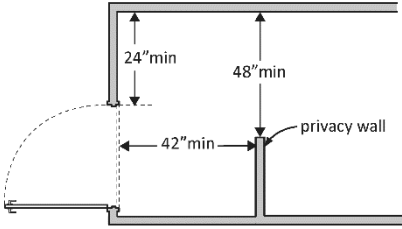
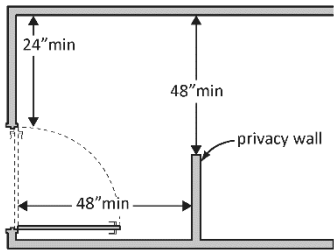
			
<p>2.14 If there is a privacy wall and the door swings out, is there at least 24 inches of maneuvering clearance beyond the door latch side and 42 inches to the privacy wall? [404.2.4]</p>	<p><input type="checkbox"/> Yes</p> <p><input type="checkbox"/> Not applicable</p>		<p>Measurement of maneuvering clearance (in inches):</p> <p>If "Not applicable" marked, indicate why:</p>
<p>2.15 If there is a privacy wall and the door swings in, is there at least 24 inches of maneuvering clearance beyond the door latch side and at least 48 inches to the privacy wall if there is no door closer or at least 54 inches if there is a door closer? [404.2.4]</p>	<p><input type="checkbox"/> Yes</p> <p><input type="checkbox"/> Not applicable</p>		<p>Measurement of maneuvering clearance (in inches):</p> <p>If "Not applicable" marked, indicate why:</p>

In the Toilet Room

2.16 Is there a clear path to at least one of each type of fixture, e.g. lavatory, hand dryer, etc., that is at least 36 inches wide?
[403.5.1]

- Yes
- Not applicable



Measurement of clear path (in inches):
If "Not applicable" marked, indicate why:

2.17 Is there clear floor space available for a person in a wheelchair to turn around, i.e. a circle at least 60 inches in diameter or a T-shaped space within a 60-inch square?
[603.2.1]

- Yes
- Not applicable

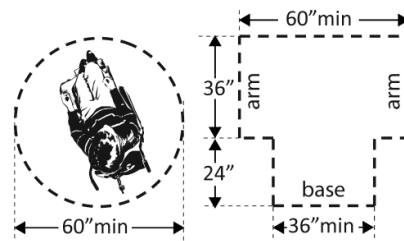

Measurement of clear floor space (in inches):
If "Not applicable" marked, indicate why:

2.18 In a single user toilet room, if the door swings in and over a clear floor space at an accessible fixture, is there a clear floor space at least 30 x 48 inches beyond the swing of the door?
[603.2.3 Exception 2]

- Yes
- Not applicable

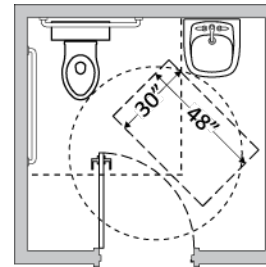

Measurement of clear floor space (in inches):
If "Not applicable" marked, indicate why:

2.19 If the mirror is over a lavatory or countertop, is the bottom edge of the reflecting surface no higher than 40 inches above the floor?
Or
If the mirror is not over the lavatory or countertop, is the bottom edge of the reflecting surface no higher than 35 inches

- Yes
- Not applicable
- Yes

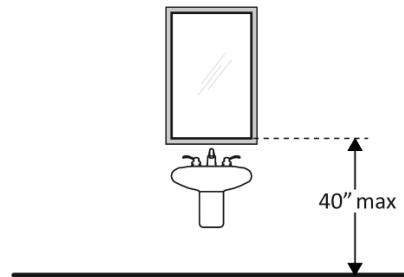

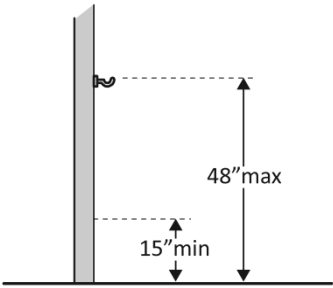

Measurement of distance from bottom of mirror to floor (in inches):
If "Not applicable" marked, indicate why:

<p>above the floor?*</p> <p>[603.3]</p>	<input type="checkbox"/> Not applicable		
<p>2.20 If there is a coat hook, is it no less than 15 inches and no greater than 48 inches above the floor?</p> <p>[603.4]</p>	<input type="checkbox"/> Yes <input type="checkbox"/> Not applicable		<p>Measurement of distance between hook and floor (in inches):</p> <p>If “Not applicable” marked, indicate why:</p>

3. Additional Access Comments

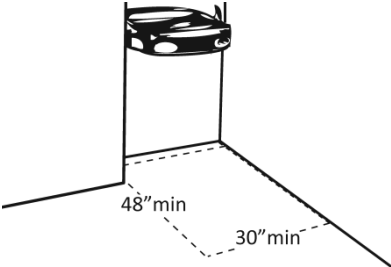
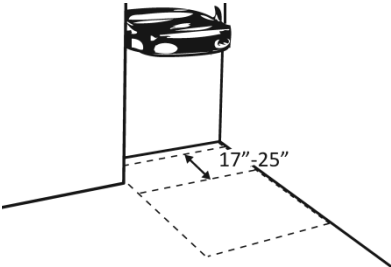
Drinking Fountains, Water Hydrants and Water Spouts

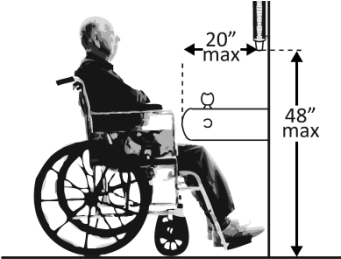
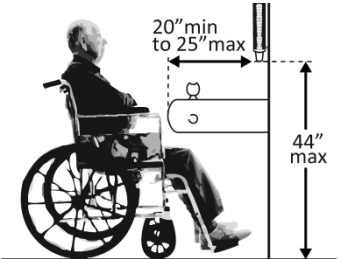

<p>3.1 Does at least one drinking fountain have a clear floor space at least 30 inches wide x at least 48 inches long centered in front of it for a forward approach?</p> <p>[See 2010 ADA Standards for Accessible Design – 602.2]</p>	<input type="checkbox"/> Yes <input type="checkbox"/> Not applicable		<p>Measurement of clear floor space (in inches):</p> <p>If “Not applicable” marked, indicate why:</p>
<p>3.2 If there is a forward approach, do no less than 17 inches and no greater than 25 inches of the clear floor space extend under the drinking fountain?</p> <p>[306.2.2, 306.2.3]</p> <p>Note: If the drinking fountain is primarily for children’s use and the spout is no more than 30 inches above the floor and no more than 3 ½ inches from the edge of the unit, a parallel</p>	<input type="checkbox"/> Yes <input type="checkbox"/> Not applicable		<p>Measurement of clear floor space (in inches):</p> <p>If “Not applicable” marked, indicate why:</p>

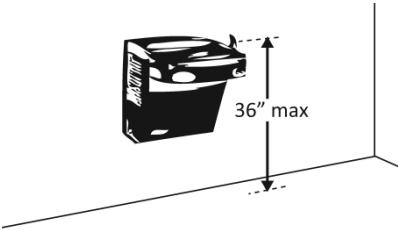
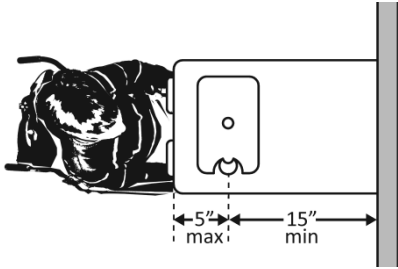
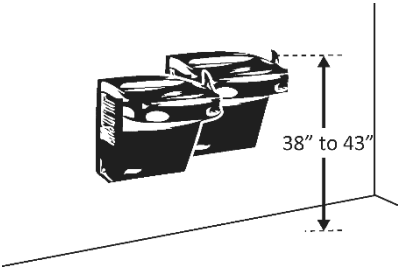
<p>approach is permitted.</p>			
<p>3.3 If the drinking fountain is no deeper than 20 inches, are the operable parts no higher than 48 inches above the floor? [308.2.2]</p>	<p><input type="checkbox"/> Yes</p> <p><input type="checkbox"/> Not applicable</p>		<p>Measurement of distance between operable parts and floor (in inches):</p> <p>If “Not applicable” marked, indicate why:</p>
<p>3.4 If the drinking fountain is no less than 20 inches and no greater than 25 inches deep, are the operable parts no higher than 44 inches above the floor? [308.2.2]</p>	<p><input type="checkbox"/> Yes</p> <p><input type="checkbox"/> Not applicable</p>		<p>Measurement of distance between operable parts and floor (in inches):</p> <p>If “Not applicable” marked, indicate why:</p>
<p>3.5 Can the control be operated with one hand and without tight grasping, pinching or twisting of the wrist?</p> <p>Is the force required to activate the control no more than 5 pounds? [309.4]</p>	<p><input type="checkbox"/> Yes</p> <p><input type="checkbox"/> Not applicable</p> <p><input type="checkbox"/> Yes</p> <p><input type="checkbox"/> Not applicable</p>		<p>If “Not applicable” marked, indicate why:</p>

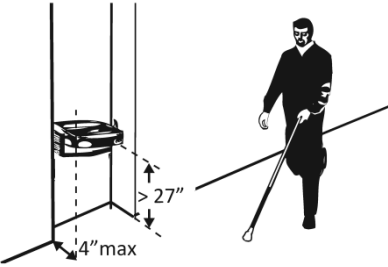
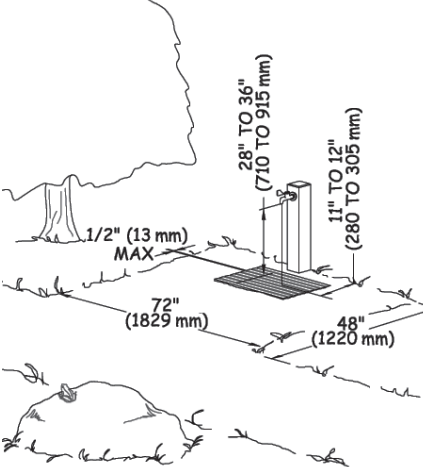
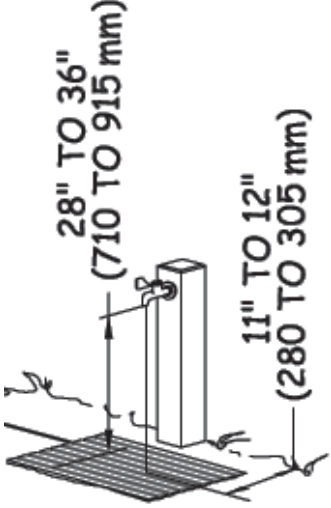
<p>3.6 Is the spout outlet no higher than 36 inches above the floor? [602.4]</p>	<p><input type="checkbox"/> Yes</p> <p><input type="checkbox"/> Not applicable</p>		<p>Measurement of distance between spout outlet and floor (in inches):</p> <p>If "Not applicable" marked, indicate why:</p>
<p>3.7 Is the spout:</p> <p>At least 15 inches from the rear of the drinking fountain?</p> <p>No more than 5 inches from the front of the drinking fountain? [602.5]</p>	<p><input type="checkbox"/> Yes</p> <p><input type="checkbox"/> Not applicable</p> <p><input type="checkbox"/> Yes</p> <p><input type="checkbox"/> Not applicable</p>		<p>Measurement of distance of spout from rear of fountain (in inches):</p> <p>Measurement of distance of spout from front of fountain (in inches):</p> <p>If "Not applicable" marked, indicate why:</p>
<p>3.8 If there is more than one drinking fountain, is there at least one for standing persons? [211.2]</p> <p>Is the spout outlet no lower than 38 inches and no higher than 43 inches above the floor? [602.7]</p>	<p><input type="checkbox"/> Yes</p> <p><input type="checkbox"/> Not applicable</p> <p><input type="checkbox"/> Yes</p> <p><input type="checkbox"/> Not applicable</p>		<p>Measurement of distance of spout from floor (in inches):</p> <p>If "Not applicable" marked, indicate why:</p>

<p>3.9 If the leading (bottom) edge of the fountain is higher than 27 inches above the floor, does the front of the fountain protrude no more than 4 inches into the circulation path? [307.2]</p>	<p><input type="checkbox"/> Yes</p> <p><input type="checkbox"/> Not applicable</p>		<p>Measurement of fountain protuberance into circulation path (in inches):</p> <p>If "Not applicable" marked, indicate why:</p>
<p>3.10 For a hydrant, is there a minimum of 72 by 48 inches of clear ground space, with the long side of the space adjoining the accessible route? [1011]</p>	<p><input type="checkbox"/> Yes</p> <p><input type="checkbox"/> Not applicable</p>		<p>Measurement of clear ground space (in inches):</p> <p>If "Not applicable" marked, indicate why:</p>
<p>3.11 Is the water spout between 11 and 12 inches from the rear center of the long side, so that people using mobility devices can approach and operate the water spout from either side?</p> <p>AND</p> <p>Is the water spout between 28 and 36 inches above the ground?</p> <p>AND</p> <p>Are the operable parts of the water spout, such as handles or</p>	<p><input type="checkbox"/> Yes</p> <p><input type="checkbox"/> Not applicable</p> <p><input type="checkbox"/> Yes</p> <p><input type="checkbox"/> Not applicable</p>		<p>Measurement of distance from water spout to rear center of long side (in inches):</p> <p>Measurement of distance from water spout to ground (in inches):</p> <p>Measurement of distance from operable parts to ground (in inches):</p> <p>If "Not applicable" marked, indicate why:</p>

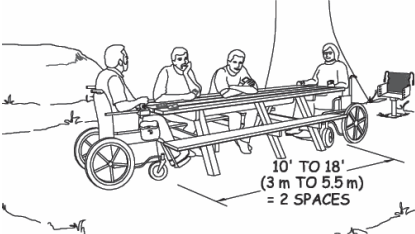
<p>levers, between 15 and 48 inches above the ground? [1011]</p>	<input type="checkbox"/> Yes <input type="checkbox"/> Not applicable		
<p>3.12 Are the operable parts operable using one hand without tightly grasping, pinching, or twisting the wrist, using no more than five pounds of force? [1011]</p> <p>Note: Water hydrants with compliant operable parts may not yet be commercially available. The U.S. Forest Service has patented an accessible handpump and has provided information about ordering at www.fs.fed.us/recreation/programs/accessibility.</p>	<input type="checkbox"/> Yes <input type="checkbox"/> Not applicable		<p>If “Not applicable” marked, indicate why:</p>
Picnic Tables			
<p>3.13 Are at least 20%, but no fewer than one, of picnic tables accessible for people who use wheelchairs? [226.1]</p>	<input type="checkbox"/> Yes <input type="checkbox"/> Not applicable		<p>Total # of tables:</p> <p># of accessible tables:</p> <p>If “Not applicable” marked, indicate why:</p>

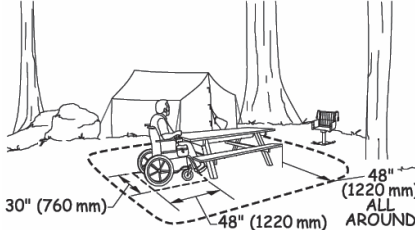
<p>3.14 Is there at least one wheelchair seating space a minimum of 30 by 48 inches for every 24 linear feet of usable space around the perimeter of a tabletop (i.e., one space for tables up to nine feet, two spaces for tables between 10 and 20 feet, etc.)? [226.1]</p>	<p><input type="checkbox"/> Yes</p> <p><input type="checkbox"/> Not applicable</p>		<p>If "Not applicable" marked, indicate why:</p>
<p>3.15 Is there a route at least 36 inches wide to accessible seating? [403.5.1]</p>	<p><input type="checkbox"/> Yes</p> <p><input type="checkbox"/> Not applicable</p>		<p>Measurement of accessible route (in inches):</p> <p>If "Not applicable" marked, indicate why:</p>
<p>3.16 Is there a clear ground space at least 30 inches wide by at least 48 inches long for a forward approach at each accessible seating space?</p> <p>AND</p> <p>Is there a clear ground space at least 48 inches wide around the usable portions of the table? [1011.2, 1011.4]</p>	<p><input type="checkbox"/> Yes</p> <p><input type="checkbox"/> Not applicable</p> <p><input type="checkbox"/> Yes</p> <p><input type="checkbox"/> Not applicable</p>		<p>Measurement of clear ground space (in inches):</p> <p>If "Not applicable" marked, indicate why:</p>

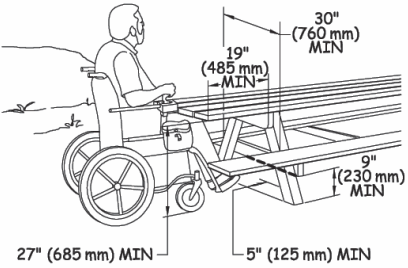
<p>3.17 Is there knee space at least 27 inches high and at least 30 inches wide?</p> <p>AND</p> <p>Is there a toe clearance of at least nine inches above the ground and extending at least five inches beyond the knee clearance?</p> <p>[1011.2, 1011.4]</p>	<input type="checkbox"/> Yes <input type="checkbox"/> Not applicable	 <p>The diagram shows a person in a wheelchair approaching a set of stairs. Key dimensions are labeled: 30" (760 mm) MIN for the width of the clear space; 19" (485 mm) MIN for the height of the clear space; 9" (230 mm) MIN for the toe clearance; 5" (125 mm) MIN for the depth of the toe clearance; and 27" (685 mm) MIN for the height of the wheelchair seat.</p>	<p>Measurement of knee space (in inches):</p> <p>Measurement of toe clearance (in inches):</p> <p>If "Not applicable" marked, indicate why:</p>
---	---	---	---

<p>3.18 Does the slope of the clear ground space not exceed 1:48 (2%) in any direction?</p> <p>OR</p> <p>Not exceed 1:33 (3%) for unpaved surfaces or surfaces not built with boards?</p> <p>[1011.2]</p>	<input type="checkbox"/> Yes <input type="checkbox"/> Not applicable		<p>Measurement of slope (in inches):</p>
--	---	--	--

Benches

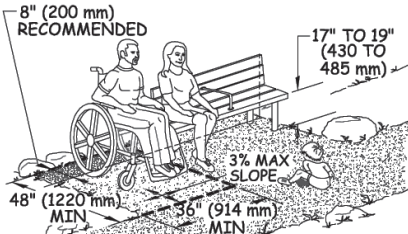
<p>3.19 Is there a minimum of 36 by 48 inches of clear ground space provided next to the bench, with one side of the clear space adjoining (but not overlapping) the accessible route?</p> <p>[1011.2]</p>	<input type="checkbox"/> Yes <input type="checkbox"/> Not applicable	 <p>The diagram shows a person in a wheelchair and another person sitting on a bench. Key dimensions are labeled: 8" (200 mm) RECOMMENDED for the height of the clear space; 17" TO 19" (430 TO 485 mm) for the height of the bench seat; 3" MAX SLOPE for the ground surface; 48" (1220 mm) MIN for the width of the clear space; and 36" (914 mm) MIN for the depth of the clear space.</p>	<p>Measurement of clear ground space (in inches):</p> <p>If "Not applicable" marked, indicate why:</p>
---	---	---	--

<p>3.20 Is the bench seat a minimum of 42 inches long, 20 to 24 inches deep, and 17 to 19 inches above the ground?</p> <p>[1011.2]</p>	<input type="checkbox"/> Yes <input type="checkbox"/> Not applicable		<p>If "Not applicable" marked, indicate why:</p>
---	---	--	--

<p>3.21</p>	<p>If installing a bench with a back support, does the bench have a back support that runs the full length of the seat and at least one arm rest? [1011.2]</p> <p>Note: Although there are no technical requirements for the bench itself, providing a bench with at least one armrest and back support that runs the full length of the bench is helpful. It is recommended that the arm rest either be centered on the bench or be placed at the end farthest from the clear space, to ensure a person using a mobility device can transfer from the device to the bench and back.</p>	<p><input type="checkbox"/> Yes</p> <p><input type="checkbox"/> Not applicable</p>		<p>If “Not applicable” marked, indicate why:</p>
<p>3.22</p>	<p>Do at least 20% of the benches, but no less than one, comply with the above requirements? [1011]</p>	<p><input type="checkbox"/> Yes</p> <p><input type="checkbox"/> Not applicable</p>		<p>Number of benches that comply:</p> <p>If “Not applicable” marked, indicate why:</p>

Trash and Recycling Receptacles

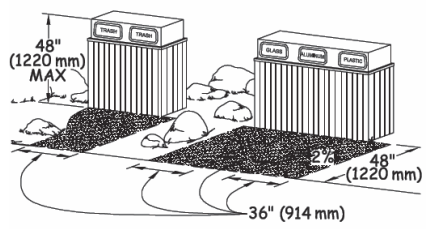
<p>3.23</p>	<p>Is there a clear ground space at least 30 inches wide by at least 48 inches long for a forward approach to the receptacle opening?</p> <p>OR</p> <p>Is there a clear ground space at least 30 inches wide by at least 60 inches long for a side approach to the receptacle opening?</p>	<p><input type="checkbox"/> Yes</p> <p><input type="checkbox"/> Not applicable</p>		<p>Measurement of clear ground space (in inches):</p> <p>If “Not applicable” marked, indicate why:</p>
--------------------	--	--	--	--

[1011.2, 1011.3]			
3.24 Are the operable parts of the receptacles, such as handles or latches, no less than 15 inches and no more than 48 inches above the ground? [1011.2, 1011.3]	<input type="checkbox"/> Yes <input type="checkbox"/> Not applicable		Measurement of distance between operable parts and ground (in inches): If "Not applicable" marked, indicate why:
3.25 Are the operable parts maneuverable with one hand without requiring tight grasping, pinching or twisting of the wrist? [1011.2, 1011.3] Note: Receptacles that keep out large animals and that also meet accessibility standards are currently not commercially available. Additionally, dumpster-type trash and recycling receptacles are not required to comply with the technical requirements for operable parts because the openings are typically more than 48 inches above the ground.	<input type="checkbox"/> Yes <input type="checkbox"/> Not applicable		If "Not applicable" marked, indicate why:
3.26 Does the slope of the clear ground space not exceed 1:48 (2%) in any direction? OR Not exceed 1:33 (3%) for unpaved	<input type="checkbox"/> Yes <input type="checkbox"/> Not applicable		Measurement of slope (in inches):

<p>3.28</p>	<p>If the trailhead sign also provides racks or bins for maps and brochures, is the trailhead sign centered at the rear of a 30 by 48 inch-minimum clear ground space?</p> <p>AND</p> <p>Is the slope of the clear ground space no greater than 1:48 (2%) in any direction?</p> <p>AND</p> <p>Are the racks/bins located a minimum of 15 inches and a maximum of 48 inches above the ground?</p> <p>AND</p> <p>Are the racks/bins operable using one hand without tightly grasping, pinching or twisting the wrist, with no more than five pounds of pressure? [1017.10]</p>	<p><input type="checkbox"/> Yes</p> <p><input type="checkbox"/> Not applicable</p> <p><input type="checkbox"/> Yes</p> <p><input type="checkbox"/> Not applicable</p> <p><input type="checkbox"/> Yes</p> <p><input type="checkbox"/> Not applicable</p> <p><input type="checkbox"/> Yes</p> <p><input type="checkbox"/> Not applicable</p>		<p>Measurement of clear ground space (in inches):</p> <p>If “Not applicable” marked, indicate why:</p>
<p>3.29</p>	<p>If the trailhead sign identifies the name of the trail, does the name of the trail comply with the technical requirements for visual characters in section 703.5 of the ABA Standards https://www.access-board.gov/guidelines-and-standards/buildings-and-sites/about-the-aba-</p>	<p><input type="checkbox"/> Yes</p> <p><input type="checkbox"/> Not applicable</p>		<p>If “Not applicable” marked, indicate why:</p>

[standards/aba-standards/chapter-7-communication-elements-and-features](#)? Specifically, these technical features relate to contrast of the characters and their background, and the character size and style.
[1017.10]

Note: Tactile characters, Braille and the International Symbol of Accessibility are not required on trailhead information signs.

Viewing Areas and Overlooks

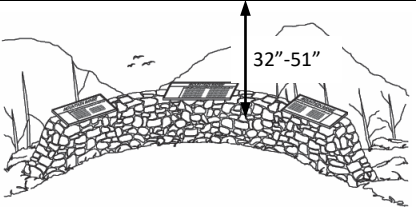
<p>3.30</p> <p>Does the viewing area or overlook provide a clear ground space at least 36 by 48 inches that is positioned for either a forward or parallel approach?</p> <p>AND</p> <p>Is there one full, unobstructed side of the clear ground space adjoining the accessible route?</p> <p>[See Outdoor Developed Areas: A Summary of Accessibility Standards for Federal Outdoor Developed Areas – 1015.2, 1015.3]</p>	<p><input type="checkbox"/> Yes</p> <p><input type="checkbox"/> Not applicable</p> <p><input type="checkbox"/> Yes</p> <p><input type="checkbox"/> Not applicable</p>		<p>Measurement of clear ground space (in inches):</p> <p>If “Not applicable” marked, indicate why:</p>
<p>3.31</p> <p>Is the viewing space adjacent to the clear ground space?</p> <p>AND</p> <p>Is the viewing space free and clear of obstructions between 32 and 51 inches above the ground, extending the full width of the clear ground space?</p> <p>[1015.2, 1015.3]</p>	<p><input type="checkbox"/> Yes</p> <p><input type="checkbox"/> Not applicable</p> <p><input type="checkbox"/> Yes</p> <p><input type="checkbox"/> Not applicable</p>	 <p>The diagram shows a cross-section of a viewing space. A stone wall or overlook structure is shown with a flat top surface. An arrow points from the ground level to the top surface, with the text "32\"-51\" written next to it. The background shows a landscape with hills and trees.</p>	<p>If “Not applicable” marked, indicate why:</p>

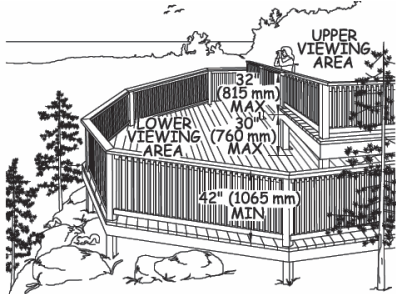
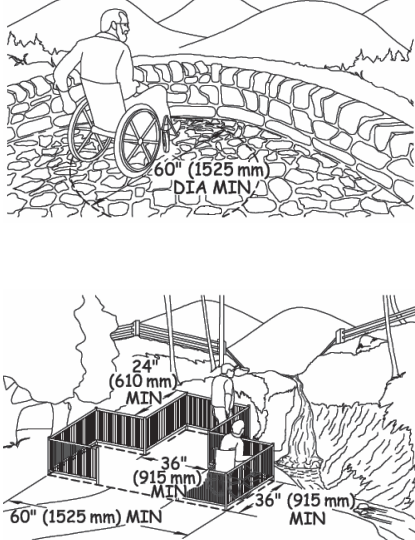
<p>3.32 If there is a dropoff of more than 30 inches, does the viewing area or overlook have railings or other barriers that comply with the height and opening requirements of the International Building Code, sections 1012.2 and 1012.3?</p>	<input type="checkbox"/> Yes <input type="checkbox"/> Not applicable		<p>If “Not applicable” marked, indicate why:</p>
<p>3.33 If railings or other barriers are used, do they still provide for an unobstructed view for someone using a mobility device, such as a wheelchair? [1015.2, 1015.3]</p> <p>Note: See-through glass panels are an example of a safety barrier that still provides unobstructed viewing.</p>	<input type="checkbox"/> Yes <input type="checkbox"/> Not applicable		<p>If “Not applicable” marked, indicate why:</p>
<p>3.34 Does the viewing area or overlook provide a turning space at least 60 inches in diameter?</p> <p>OR</p> <p>A T-shaped space with an arm at least 60 by 36 inches and a base at least 36 by 24 inches, to allow people using mobility devices the ability to turn around? [1015.4]</p>	<input type="checkbox"/> Yes <input type="checkbox"/> Not applicable <input type="checkbox"/> Yes <input type="checkbox"/> Not applicable		<p>Measurement of turning space (in inches):</p> <p>If “Not applicable” marked, indicate why:</p>

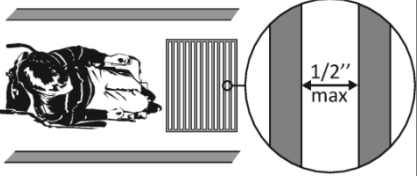

<p>3.35 Does the slope of the clear ground space of the viewing area or overlook not exceed 1:48 (2%) in any direction?</p> <p>OR</p> <p>Not exceed 1:33 (3%) for unpaved surfaces or surfaces not built with boards? [1015.5, 1015.6]</p>	<p><input type="checkbox"/> Yes</p> <p><input type="checkbox"/> Not applicable</p> <p><input type="checkbox"/> Yes</p> <p><input type="checkbox"/> Not applicable</p>		<p>Measurement of slope (in inches):</p> <p>If “Not applicable” marked, indicate why:</p>
<p>3.36 Are any openings in the clear ground space or turning space (such as between boards on an overlook deck) no larger than ½ inch?</p> <p>AND</p> <p>Is the long dimension perpendicular to the dominant direction of travel? [See 2010 ADA Standards for Accessible Design – 302.3]</p>	<p><input type="checkbox"/> Yes</p> <p><input type="checkbox"/> Not applicable</p> <p><input type="checkbox"/> Yes</p> <p><input type="checkbox"/> Not applicable</p>		<p>Measurement of space of openings (in inches):</p> <p>If “Not applicable” marked, indicate why:</p>



4. Trail Facilities	Comments
---------------------	----------

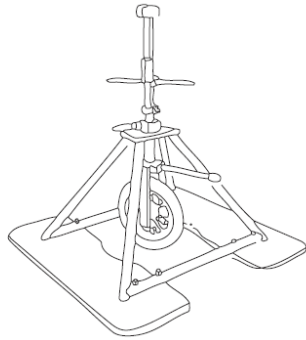

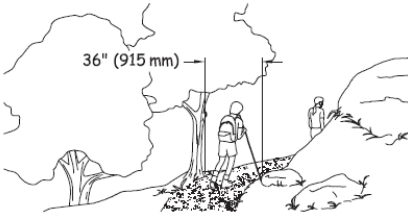
<p>4.1 Does the trail project meet one of the exceptions that preclude following the ADA technical specifications? If yes, please indicate which exception.</p>	<p><input type="checkbox"/> Compliance would substantially alter the intended purpose of the trail.</p> <p><input type="checkbox"/> Compliance would substantially alter the nature of the setting of the trail.</p> <p><input type="checkbox"/> Compliance would not be feasible due to terrain.</p> <p><input type="checkbox"/> Compliance would require construction activities that are prohibited by policy or law.</p> <p><input type="checkbox"/> Compliance would impact a protected cultural, historic, natural or environmental resource.</p>	
--	---	--

Trails		
--------	--	--

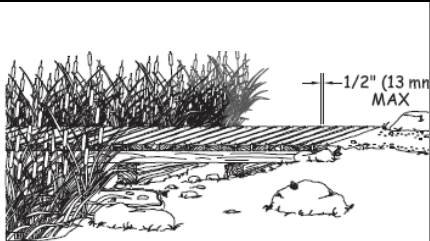
<p>4.2 Is the trail surface firm and stable? [See Outdoor Developed Areas: A Summary of Accessibility Standards for Federal Outdoor Developed Areas – 1017.2]</p>	<p><input type="checkbox"/> Yes</p> <p><input type="checkbox"/> Not applicable</p>	 <p style="font-size: small;">Note: It is recommended using a rotational penetrometer (RP) to evaluate firmness and stability.</p>	<p>Indicate surface material:</p> <p>If “Not applicable” marked, indicate why:</p>
--	--	--	--

<p>4.3 Is there a clear tread width a minimum of 36 inches? [1017.3]</p>	<p><input type="checkbox"/> Yes</p> <p><input type="checkbox"/> Not applicable</p>		<p>Measurement of clear tread width (in inches):</p> <p>If "Not applicable" marked, indicate why:</p>
<p>4.4 On unpaved or natural surface trails, are tread obstacles less than two inches high?</p> <p>OR</p> <p>On a trail surface of paved material (asphalt, concrete, paving blocks, and so forth) or built with boards (wood planks, heavy timber, concrete, fiberglass, or other manufactured material), are tread obstacles a maximum of one-half inch in height at their highest point?</p> <p>AND</p> <p>On any trail tread, are obstacles separated by a minimum of 48 inches where possible, particularly where obstacles cross the entire tread width? [1017.5]</p>	<p><input type="checkbox"/> Yes</p> <p><input type="checkbox"/> Not applicable</p> <p><input type="checkbox"/> Yes</p> <p><input type="checkbox"/> Not applicable</p> <p><input type="checkbox"/> Yes</p> <p><input type="checkbox"/> Not applicable</p>		<p>If "Not applicable" marked, indicate why:</p>

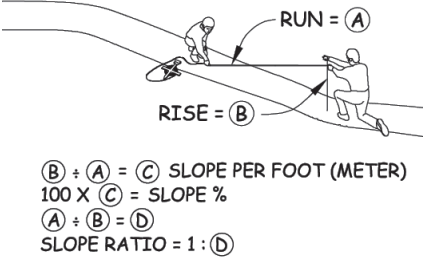
<p>4.5 Are openings in the trail surface (such as gaps in boardwalks) small enough that a sphere more than one-half inch in diameter cannot pass through? [1017.6]</p>	<input type="checkbox"/> Yes <input type="checkbox"/> Not applicable		<p>If "Not applicable" marked, indicate why:</p>
<p>4.6 Where possible, are the openings in boardwalks or bridge decking perpendicular to the direction of travel? [1017.6]</p>	<input type="checkbox"/> Yes <input type="checkbox"/> Not applicable		<p>If "Not applicable" marked, indicate why:</p>
<p>4.7 Protruding objects are defined as constructed features such as signs that extend into the clear width area of a trail, resting interval, or passing space, that are between 27 and 80 inches above the travel surface.</p> <p>Are protruding objects extending into the clear width area kept to a minimum of four inches? [1017.9]</p> <p>Note: These requirements do not apply to natural features, such as branches, rock formations, and trails that pass beneath rock ledges or through caves. Regular maintenance is required, however, to ensure brush, limbs, trees, logs and other hazards be removed from the edge of the trail.</p>	<input type="checkbox"/> Yes <input type="checkbox"/> Not applicable		<p>If "Not applicable" marked, indicate why:</p>

<p>4.8 Running slope is the ratio of vertical distance to horizontal distance, or rise to run. For instance, a slope ratio of 1:20 means that, for every foot of vertical rise, there are 20 feet of horizontal distance (or 5% grade).</p> <p>Does no more than 30% of the running slope (or grade) exceed 1:12 (8.33%)? [1017.7.1]</p>	<p><input type="checkbox"/> Yes</p> <p><input type="checkbox"/> Not applicable</p>	 <p>$B \div A = C$ SLOPE PER FOOT (METER) $100 \times C =$ SLOPE % $A \div B = D$ SLOPE RATIO = 1 : D</p>	<p>If “Not applicable” marked, indicate why:</p>
<p>4.9 Cross slope is the side-to-side slope of a trail tread. Some cross slope is necessary to provide drainage.</p> <p>On unpaved or natural surface trails, is the cross slope less than 1:20 (5% grade)?</p> <p>OR</p> <p>On a trail surface of paved material (asphalt, concrete, paving blocks, and so forth) or built with boards (wood planks, heavy timber, concrete, fiberglass, or other manufactured material), is the cross slope less than 1:48 (2% grade)? [101.7.2]</p>	<p><input type="checkbox"/> Yes</p> <p><input type="checkbox"/> Not applicable</p> <p><input type="checkbox"/> Yes</p> <p><input type="checkbox"/> Not applicable</p>	 <p>CROSS SLOPE</p> <p>RUNNING SLOPE</p>	<p>If “Not applicable” marked, indicate why:</p>

<p>4.10 Resting intervals are relatively level areas that provide opportunity for people to stop and catch their breath.</p> <p>If the running slope is steeper than 1:20 (5% grade) but less than 1:12 (8.33% grade), are there resting intervals located a minimum of every 200 feet?</p> <p>OR</p> <p>If the running slope is steeper than 1:12 (8.33% grade) but less than 1:10 (10% grade), are there resting intervals located a minimum of every 30 feet?</p> <p>OR</p> <p>If the running slope is steeper than 1:10 (10% grade) but less than 1:8 (12% grade), are there resting intervals located a minimum of every 10 feet). [1017.7.1]</p>	<p><input type="checkbox"/> Yes</p> <p><input type="checkbox"/> Not applicable</p> <p><input type="checkbox"/> Yes</p> <p><input type="checkbox"/> Not applicable</p> <p><input type="checkbox"/> Yes</p> <p><input type="checkbox"/> Not applicable</p>		<p>If “Not applicable” marked, indicate why:</p>
<p>4.11 If the resting interval is adjacent to the trail tread, does it comply with the standard set forth in ABA 304.3.2? (The turning space shall be a T-shaped space within a 60-inch square minimum with arms and base 36 inches wide minimum. Each arm of the T shall</p>	<p><input type="checkbox"/> Yes</p> <p><input type="checkbox"/> Not applicable</p>		<p>If “Not applicable” marked, indicate why:</p>

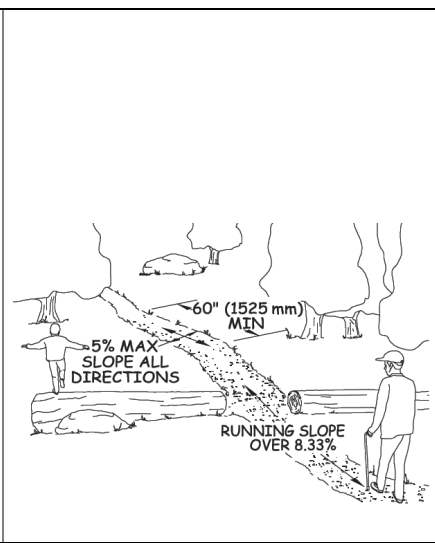
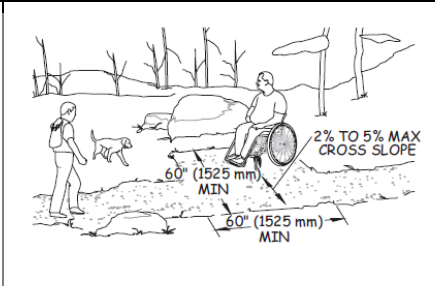
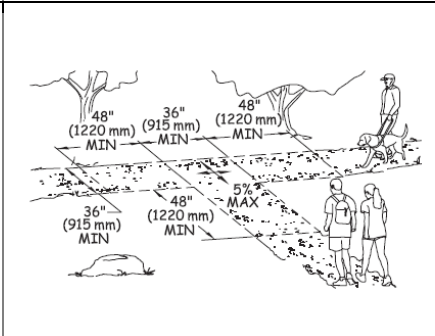
<p>be clear of obstructions 12 inches minimum in each direction and the base shall be clear of obstructions 24 inches minimum.)</p> <p>OR</p> <p>If the resting interval is beside the trail, is it at least 60 inches long and at least 36 inches wide? [1017.8]</p>	<p><input type="checkbox"/> Yes</p> <p><input type="checkbox"/> Not applicable</p>		
<p>4.12 For a tread width of less than 60 inches, are there passing spaces provided at intervals of at least 1,000 feet that are a minimum of 60 by 60 inches? [1017.4]</p>	<p><input type="checkbox"/> Yes</p> <p><input type="checkbox"/> Not applicable</p>		<p>If "Not applicable" marked, indicate why:</p>
<p>4.13 At a T-intersection of two trails, do the arms and stem of the T-shaped space extend at least 48 inches beyond the intersection to allow someone adequate space in which to turn around? [1017.4]</p>	<p><input type="checkbox"/> Yes</p> <p><input type="checkbox"/> Not applicable</p>		<p>If "Not applicable" marked, indicate why:</p>

4.14 Where gates, barriers or directional changes require users to make 90-degree or 180-degree turns, is there a minimum of 48 inches of turn clearance for a 42-inch-wide tread width?

OR

Is there a minimum of 60 inches of turn clearance for a 36-inch-wide tread width?
[1017.3]

- Yes
- Not applicable

- Yes
- Not applicable

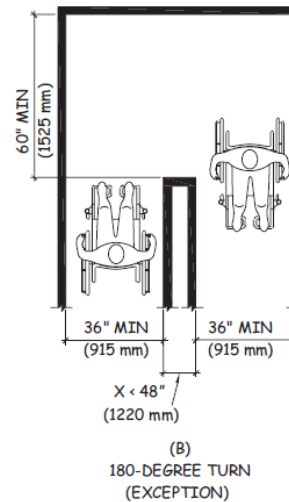
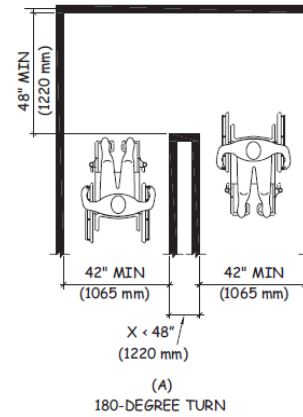

Measurement of turn clearance (in inches):
If "Not applicable" marked, indicate why:

Trailside Shelters

4.15 Does the shelter provide transfer access (raised access) at the entrance by providing a clear ground space at least 36 by 48 inches which is parallel to the open side of the shelter and adjoin the trail tread?
[1014.2.1]

OR

- Yes
- Not applicable

Measurement of clear ground space (in inches):

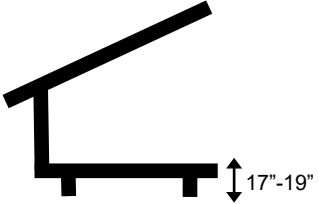
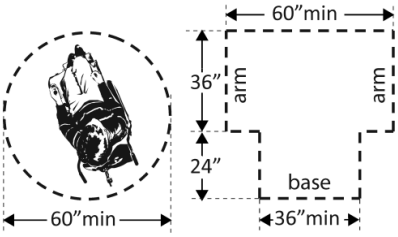
<p>Does the shelter provide roll-in access with a level entry route or a sloped entry route no more than 1:48 (2%)? [1014.2.2]</p>	<p><input type="checkbox"/> Yes</p> <p><input type="checkbox"/> Not applicable</p>		<p>Measurement of clear ground space (in inches):</p> <p>If "Not applicable" marked, indicate why:</p>
<p>4.16 For transfer access (raised access), is the shelter floor at the entrance or opening no less than 17 or no more than 19 inches high, to enable people using mobility devices the ability to pull alongside the shelter and transfer from the device to the shelter floor and back? [1014.2.1]</p>	<p><input type="checkbox"/> Yes</p> <p><input type="checkbox"/> Not applicable</p>		<p>Measurement of distance from raised access to ground (in inches):</p> <p>If "Not applicable" marked, indicate why:</p>
<p>4.17 For roll-in access, is there a turning space at least 60 inches in diameter or a T-shaped space with an arm at least 60 by 36 inches and a base at least 36 inches wide and 24 inches long inside the shelter? [1014.2.2]</p>	<p><input type="checkbox"/> Yes</p> <p><input type="checkbox"/> Not applicable</p>		<p>Measurement of turning space (in inches):</p> <p>If "Not applicable" marked, indicate why:</p>
<p>4.18 If the floor surface is constructed of asphalt, concrete or boards, is the slope of the floor surface no more than 1:48 (2%) in any direction?</p> <p>OR</p> <p>If the floor surface is constructed with other materials, is the slope of the floor surface no greater than 1:20 (5%) in any direction? [1014.3]</p>	<p><input type="checkbox"/> Yes</p> <p><input type="checkbox"/> Not applicable</p> <p><input type="checkbox"/> Yes</p> <p><input type="checkbox"/> Not applicable</p>		<p>Slope of floor space (in inches):</p> <p>Slope of floor space (in inches):</p> <p>If "Not applicable" marked, indicate why:</p>



MISSOURI DEPARTMENT OF NATURAL RESOURCES

FINANCIAL ASSISTANCE AGREEMENT

Assistance as described herein is hereby offered and accepted effective upon signature of authorized officials for the dates indicated in Budget Period and Project Period below.

RECIPIENT INFORMATION				
RECIPIENT NAME			RECIPIENT TELEPHONE NUMBER WITH AREA CODE	
ADDRESS		CITY	STATE	ZIP CODE
UNIQUE ENTITY ID	AWARD NUMBER	BUDGET PERIOD	PROJECT PERIOD	
RECIPIENT PROJECT MANAGER NAME		RECIPIENT PROJECT EMAIL ADDRESS	PROJECT MANAGER TELEPHONE NUMBER WITH AREA CODE	

PROJECT INFORMATION				
RECIPIENT PROJECT TITLE AND PROJECT DESCRIPTION (ATTACH ADDITIONAL PAGES AS NECESSARY)				
TYPE OF ASSISTANCE		SOURCE OF FUNDING	CFDA NUMBER	CFDA NAME
New Award	Amendment	Federal State Other		
STATE PROJECT MANAGER NAME		STATE PROJECT MANAGER TELEPHONE NUMBER WITH AREA CODE	INDIRECT COST RATE FOR RECIPIENT	
RESEARCH AND DEVELOPMENT	RESEARCH AND DEVELOPMENT COMMENTS IF NEEDED			
YES NO				

PROJECT FUNDING	Original Amount	Original Percentage	Amended Amount	Amended Percentage	Total Amount	Total Percentage
Federal Award:	\$	%	\$	%	\$	%
State/Other Award:	\$	%	\$	%	\$	%
Recipient Match:	\$	%	\$	%	\$	%
Total Award:	\$	%	\$	%	\$	%

AGREEMENT ADMINISTRATION					
THE ATTACHMENTS IDENTIFIED BELOW ARE INCORPORATED BY REFERENCE AS THOUGH FULLY RESTATED HEREIN. THE RECIPIENT AGREES TO ADMINISTER THIS AGREEMENT IN ACCORDANCE WITH ALL APPLICABLE FEDERAL AND STATE LAWS AND REGULATIONS INCLUDING, BUT NOT LIMITED TO:					
APPLICABLE PROGRAM GUIDELINES		APPLICATION NUMBER		RECIPIENT APPLICATION, AS NEGOTIATED, DATED	
BUDGET PLAN	DETAILED SCOPE OF WORK	SPECIAL CONDITIONS	GENERAL TERMS AND CONDITIONS	SUSPENSION/DEBARMENT	PUBLIC LAW
Attachment #	Attachment #	Attachment #	Attachment #	Attachment #	Attachment #
PUBLICATIONS	EPA MBE/WBE UTILIZATION	CERTIFICATE REGARDING LOBBYING	INVOICE	ADDITIONAL ATTACHMENTS	
Attachment #	Attachment # _____	Attachment #	Attachment #	Attachment #	Attachment #

AMENDMENT INFORMATION	
AMENDMENT ID	AMENDMENT DESCRIPTION (ATTACH ADDITIONAL PAGES AS NECESSARY)

FEDERAL AWARD INFORMATION (ATTACH ADDITIONAL PAGES AS NECESSARY)			
FEDERAL AWARD PROJECT TITLE AND DESCRIPTION			
FEDERAL AWARING AGENCY		FEDERAL AWARD ID NUMBER	PASS THROUGH ENTITY NAME
			MoDNR,
FEDERAL FUNDING YEAR	FEDERAL AWARD DATE	TOTAL AMOUNT OF FEDERAL AWARD	INDIRECT COST RATE FOR MoDNR
		\$	%
HAVE YOU OR AN IMMEDIATE FAMILY MEMBER EVER SERVED IN THE U.S. ARMED FORCES? YES NO		*This question is optional.	
IF YES, WOULD YOU LIKE INFORMATION ABOUT MILITARY-RELATED SERVICES IN MISSOURI? YES NO		*This question is optional.	

APPROVAL

I am at least 18 years old, and certify I am duly authorized to accept this award for recipient using electronic signature. The recipient understands and agrees it is a condition precedent to receive reimbursement that recipient comply with and is not in breach or default of all terms and conditions of this award stated above and attached hereto, and that no request for reimbursement will be processed unless it is presented in proper form.

RECIPIENT ORGANIZATION AUTHORIZED OFFICIAL NAME AND TITLE (TYPED)	SIGNATURE	DATE
DEPARTMENT OF NATURAL RESOURCES DIRECTOR OR DESIGNEE NAME (TYPED)	SIGNATURE	DATE



MISSOURI DEPARTMENT OF NATURAL RESOURCES
 DIVISION OF STATE PARKS
RECREATIONAL TRAILS PROGRAM CFDA 20.219
QUARTERLY REPORT FORM

Please attach completed Quarterly Report Form and email to: msspgrants@dnr.mo.gov

PROJECT SPONSOR

NAME		PROJECT NUMBER	
PROJECT TITLE			CONSTRUCTION START DATE
QUARTERLY PERIOD YEAR	<input type="checkbox"/> JAN. - MARCH DUE APRIL 30 TH	<input type="checkbox"/> APRIL - JUNE DUE JULY 31 ST	<input type="checkbox"/> JULY - SEPT. DUE OCT. 31 ST
		<input type="checkbox"/> OCT. - DEC. DUE JAN. 31 ST	FOR FISCAL YEAR

PROJECT SCOPE

PROGRESS: (State project scope elements begun and/or completed.)

STATUS: (Explain what remains to be done.)

PERCENTAGE COMPLETE	EXPECTED COMPLETION DATE
---------------------	--------------------------

COMMENTS

SIGNATURE OF RESPONSIBLE OFFICIAL	DATE REPORT COMPLETED
-----------------------------------	-----------------------

TITLE

EMAIL ADDRESS	TELEPHONE NUMBER
---------------	------------------



MISSOURI DEPARTMENT OF NATURAL RESOURCES
 DIVISION OF STATE PARKS
RECREATIONAL TRAILS PROGRAM CFDA 20.219
EXTENSION REQUEST

PLEASE EMAIL REQUESTS TO mspgrants@dnr.mo.gov

PROJECT SPONSOR

NAME		PROJECT NUMBER
PROJECT TITLE		
PROJECT SCOPE		
PROJECT PERIOD	START DATE TO END DATE	DATE OF REQUEST

REASON FOR EXTENSION

WEATHER/NATURAL DISASTER OTHER (EXPLAIN) _____

MATERIALS/SUPPLY ISSUES _____

CHANGES IN STAFF/PERSONNEL _____

PROJECT PROGRESS

PERCENTAGE OF COMPLETION TO DATE	EXPECTED COMPLETION DATE: (Must be within one year of project period end date)
EXPLANATION OF WHAT STILL NEEDS TO BE DONE	

CONTACT NAME	CONTACT TELEPHONE NUMBER	
CONTACT EMAIL		
ADDRESS	CITY	ZIP
NAME OF RESPONSIBLE OFFICIAL FOR PROJECT		

FOR GMS OFFICE USE ONLY

REQUEST FOR EXTENSION IS

APPROVED DENIED WILL REQUIRE ADDITIONAL INFORMATION

APPROVER	DATE APPROVED	REVISED PROJECT END DATE
----------	---------------	--------------------------

COMMENTS

The Grants Management Section will contact you regarding this request.



MISSOURI DEPARTMENT OF NATURAL RESOURCES
 DIVISION OF STATE PARKS
RECREATIONAL TRAILS PROGRAM CFDA 20.219
REIMBURSEMENT STATEMENT

PROJECT NUMBER	BILLING NUMBER
BILLING STATUS	<input type="checkbox"/> FINAL <input type="checkbox"/> PARTIAL

PROJECT SPONSOR

NAME	TELEPHONE NUMBER
------	------------------

ADDRESS AS SHOWN ON FEDERAL TAX RETURN	CITY	STATE	ZIP
--	------	-------	-----

FEDERAL ID NUMBER

PROJECT TITLE

THIS BILLING INCLUDES COSTS INCURRED FROM	DATE	TO	DATE
---	------	----	------

TOTAL COSTS THIS BILLING (Should match total from Reimbursement Log)	AMOUNT REQUESTED FOR REIMBURSEMENT
--	------------------------------------

By signing this report, I certify I am authorized to legally bind the project sponsor, and to the best of my knowledge and belief that the report is true, complete, and accurate, and the expenditures, disbursements and cash receipts are for the purposes and objectives set forth in the terms and conditions of the Federal award. I am aware that any false, fictitious, or fraudulent information, or the omission of any material fact, may subject me to criminal, civil or administrative penalties for fraud, false statements, false claims or otherwise. (U.S. Code Title 18, Section 1001 and Title 31, Sections 3729–3730 and 3801–3812).

NAME OF RESPONSIBLE OFFICIAL (Type or Print)
--

SIGNATURE OF RESPONSIBLE OFFICIAL

TITLE	DATE
-------	------

THIS REQUEST MUST INCLUDE A COPY OF THE REIMBURSEMENT LOG AND THE NECESSARY SUPPORTING DOCUMENTATION (e.g., COPIES OF INVOICES AND CHECKS, SIGNED EMPLOYEE TIMESHEETS, VOLUNTEER TIMESHEETS, ETC.).

COMMENTS FOR REVIEWER

--

CHANGE ORDER No. 1

CONTRACTOR: _____
 PROJECT NAME: _____

LPA: _____
 PROJECT NO.: _____

The Contractor is hereby directed to make the following changes from the contract:

1. DESCRIPTION AND REASON FOR CHANGE:									
2. COST OF WORK AFFECTED BY THIS CHANGE ORDER.									
EST. LINE NO.	CONTRACT ITEM NO.	ITEM DESCRIPTION	UNITS PREVIOUSLY PROVIDED FOR	UNITS TO BE CONSTRUCTED	UNITS OVERRUN, UNDERRUN, CONTINGENT	UNIT PRICE	CONTRACT OR AGREED UNIT PRICE	AMOUNT OF OVERRUN OR PLUS CONTINGENT	AMOUNT OF UNDERRUN OR MINUS CONTINGENT
TOTALS:								\$0.00	\$0.00
3. SETTLEMENT FOR COST OF THE ABOVE CHANGE TO BE MADE AT CONTRACT UNIT PRICES, EXCEPT AS NOTED:									
N/A									
4 COMMENTS:									
5 COST ADJUSTMENTS TO THE CONTRACT:									
1. CONTRACT AMOUNT									
2. OVERRUN THIS ORDER			\$0.00						
3. OVERRUN PREVIOUS									
4. UNDERRUN THIS ORDER			\$0.00						
5. UNDERRUN PREVIOUS									
6. PROJECT TOTAL				\$0.00					
THE TERMS OF SETTLEMENT OUTLINED ABOVE ARE HEREBY AGREED TO:									
APPROVED: (OWNER)					APPROVED: (CONTRACTOR)				
DATE					DATE				
APPROVED : MODOT					APPROVED: (CONSTRUCTION ENGINEER)				
DATE					DATE				

APPENDIX I. PROJECT CLOSEOUT FORMS AND CHECKLIST

The following items are required documents to submit when closing out your project and submitting your final reimbursement request. Please submit **one copy** of each item to the Grants Management Section (GMS), at the address below. Use this checklist to ensure that you've included all required documentation in the Project Closeout Packet.

RTP Planner
Grants Management Section
Missouri State Parks
PO Box 176
Jefferson City, MO 65102-0176
mispgrants@dnr.mo.gov

- Reimbursement Statement Form. Under "Billing Status," check the box marked "Final."
- Reimbursement Log Form
- Individual and Volunteer Time Record Form
- Equipment Use Record, as appropriate
- Final Inspection Request Form
- As-Built Site Map, as appropriate
- As-Built Floor Plans, as appropriate
- Accessibility Checklist, as appropriate
- OPDMD Assessment and Written Policy, as appropriate
- Post Construction Certification Form
- Control and Tenure Documentation, if not already submitted
- Recorded Stewardship Declaration, official copy from recorder of deeds



MISSOURI DEPARTMENT OF NATURAL RESOURCES
 DIVISION OF STATE PARKS
RECREATIONAL TRAILS PROGRAM CFDA 20.219
FINAL INSPECTION REQUEST

PLEASE EMAIL THIS FORM WHEN YOU MAIL THE FINAL REIMBURSEMENT PACKAGE.
PLEASE EMAIL REQUESTS TO mspgrants@dnr.mo.gov

PROJECT SPONSOR

NAME		PROJECT NUMBER
PROJECT TITLE		
PROJECT SCOPE		
PROJECT PERIOD	DATE TO DATE	DATE THAT FINAL REIMBURSEMENT PACKAGE WAS MAILED

RESPONSIBLE OFFICIAL FOR PROJECT

NAME	CONTACT TELEPHONE NUMBER	
	OFFICE	CELL
CONTACT EMAIL		

WHERE WILL STAFF MEET SPONSOR?

- OFFICE PROJECT LOCATION

ADDRESS OF MEETING LOCATION

ADDRESS	CITY	STATE	ZIP
---------	------	-------	-----

NOTES

PLEASE IDENTIFY THREE DATES WITHIN 30 DAYS OF SUBMITTING THIS FORM THAT THE RESPONSIBLE OFFICIAL COULD ACCOMMODATE A GMS MEMBER FOR THE FINAL INSPECTION/WALK THROUGH:

DATE	<input type="checkbox"/> MORNING	<input type="checkbox"/> AFTERNOON
DATE	<input type="checkbox"/> MORNING	<input type="checkbox"/> AFTERNOON
DATE	<input type="checkbox"/> MORNING	<input type="checkbox"/> AFTERNOON

Upon receiving this request, a GMS staff member will call you to confirm a final inspection meeting.

POST CONSTRUCTION CERTIFICATE

This certificate must be submitted with the final billing. The form must be signed by the project sponsor and by the architect or engineer who supervised the construction. If the project did not involve a contract architect or engineer, the project sponsor's architect, engineer or project manager should inspect the project and sign the form.

As-Built Plans

One copy of as-built plans must be submitted to the Grants Management Section, with a copy retained in the project sponsor's file. If deviations in design or site location were not made to plans previously submitted the Grants Management Section, a set of the original as-built plans with a revised date is sufficient. As-built plans must include:

- a) A site plan showing the location of the project area and any trailhead/trailside facilities.
- b) Elevations and floor plans of structures.
- c) A stamp by a certified architect or engineer, if the project involved either.

POST CONSTRUCTION CERTIFICATION:

I hereby certify that construction of Recreational Trails Program Project Number _____ has been completed in accordance with the original and revised plans and specifications on file with the Grants Management Section. The plans and specifications are consistent with the scope of the project approved by the Federal Highway Administration and the Grants Management Section, on behalf of the Missouri Department of Natural Resources. The project has been constructed in accord with all applicable federal, state and local building rules and regulations and is acceptable for public use.

A RESPONSIBLE OFFICIAL FROM THE SPONSORING ORGANIZATION MUST SIGN AND DATE THE CERTIFICATION

Signature of Project Sponsor

DATE _____

Signature of Project Architect/Engineer

DATE _____

Certification Number of Stamp (if applicable) _____

The following is a SAMPLE Declaration which may be used as guide to develop a document for recording in accordance with RTP program requirements and RSMo 59.310. Missouri law for miscellaneous documents requires the document to be dated, signed, and notarized, and for the property description including deed book and page number to appear on the first page, or to use a cover page with this information in accordance with the statutory requirements. In addition, each county may have additional requirements for recording real estate documents.

[3-inch margin reserved for recording; additional fee if margin not reserved]

WHEN RECORDED MAIL TO:

[insert owner contact information; owner is responsible to provide an additional copy to Grant Administrator]

Space above line reserved for recorder's use

DECLARATION OF DEED RESTRICTION

THIS DECLARATION made this ___ day of ___, 20XX, _____ by [insert legal name of property owner], [mailing address] (hereinafter referred to as "Owner" ; *this is the grantor, if required by recorder's office*). Owner hereby declares that the below-described real property is and shall be held transferred, sold, and conveyed subject to the following conditions and restrictions in accordance with the covenants made for the award of grant funds in Project XXXX administered by the Missouri Department of Natural Resources ("Department"; *this is grantee and holder, if required by the recorder's office*), P.O. Box 176, Jefferson City, MO 65102, through funds made available by the United States Department of Transportation, Federal Highways Administration, Recreational Trails Program (RTP):

[insert description of project area, must begin on page 1 of document],
hereinafter referred to as "Property."

In accordance with the RTP grant award and 2 CFR 200.316, the Property has been improved with grant funds and must be held in trust as trustees for the beneficiaries of the program funds used to the develop the Property by limiting use of the Property to outdoor recreational use, and maintaining and operating the Property in accordance with Title VI of the Civil Rights Act of 1964 such that no person shall, on the grounds of race, color, or national origin, be excluded from participation in, be denied the benefits of, or be otherwise subjected to discrimination in the use of this improvement paid by federal financial assistance. See 49 CFR Part 21 (civil rights laws), for 25 years from the signature date on this document. This Declaration shall be binding upon Owner and Owner's heirs, successors, assigns and other transferees in interest (hereinafter "Transferees"), and shall run with the land. Each instrument

